

The logo for CEA (Commissariat à l'énergie atomique et aux énergies alternatives) features the lowercase letters 'cea' in a white, sans-serif font. A thin green horizontal line is positioned below the letters.

EuroCorr 2021 – 20/24 September 2021

DE LA RECHERCHE À L'INDUSTRIE

Experimental characterization and modeling of intergranular fracture of austenitic stainless steels in PWR environment

Rachma Azihari¹, Jérémy Hure¹, Marc Legros², Benoît Tanguy¹

¹ CEA SACLAY, 91191 Gif-sur-Yvette

² CEMES-CNRS, 29 rue Jeanne Marvig, 31500 Toulouse



1. Stress Corrosion Cracking (SCC) issue in PWR environment

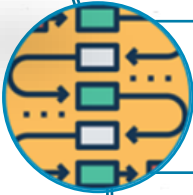

2. Study methodology

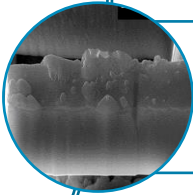

3. Grain boundary strength of oxidized Si enriched steel



4. Conclusions and perspectives

Context

Pressurized water reactor conditions (PWR): Water (1000ppm B, 2ppm Li) at 300°C, 155bars + neutrons irradiation



Irradiation Assisted Stress Corrosion Cracking (IASCC) of austenitic stainless steel constitutive of the internal parts of the reactor

Figure 1: Reactor assembly

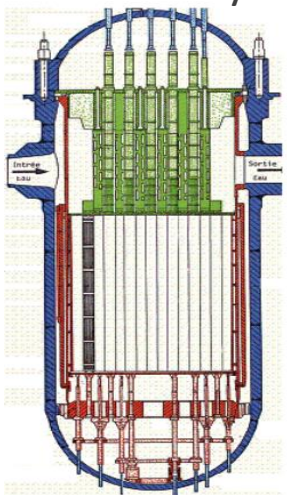
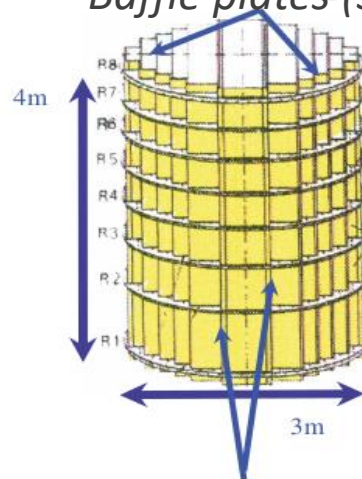

Figure 2: Reactor internal parts

Baffle plates (304L)







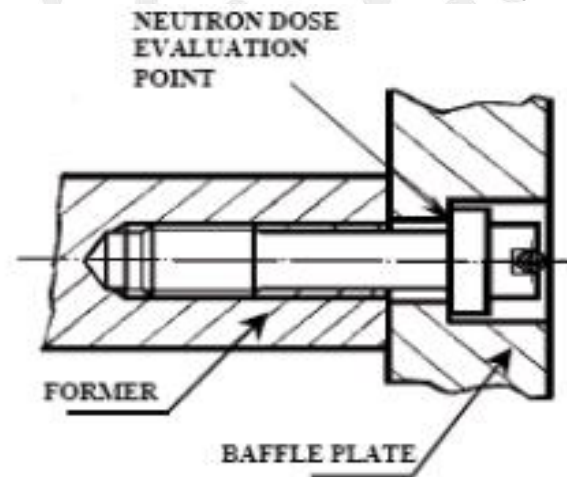

Former plates (304L)

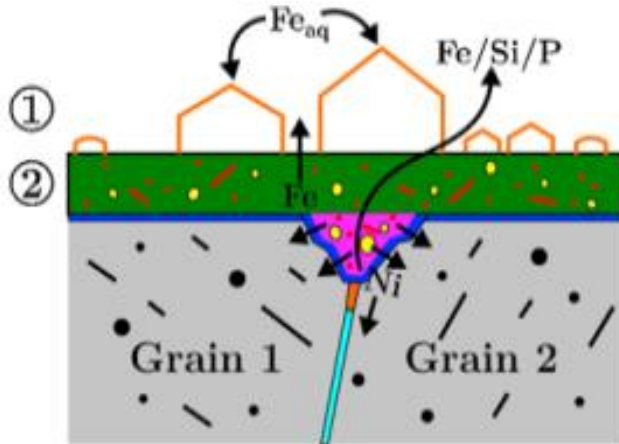
Figure 3: Baffle to former bolt (316L)



B. Tanguy. Corrosion sous contrainte assistée par l'irradiation des aciers inoxydables austénitiques (IASCC). Revue de Métallurgie, 108(1) :39-46, 2011.



-  Crystallites
-  Inner oxide in epitaxy with the substrate
-  Nickel enriched area
-  Oxide penetration at grain boundary
-  Grain boundary RIS
-  Si/P depleted Ni-rich area

Austenitic stainless steel corrosion in PWR environment
 → Duplex oxide with 2 layers

Deeper penetration of oxide at GB:

- GBs act as diffusion short cuts
- Irradiation → Radiation induced segregation (RIS) at GB → change of chemistry

→ Increase IGSCC susceptibility of irradiated austenitic stainless steels

Intergranular cracking

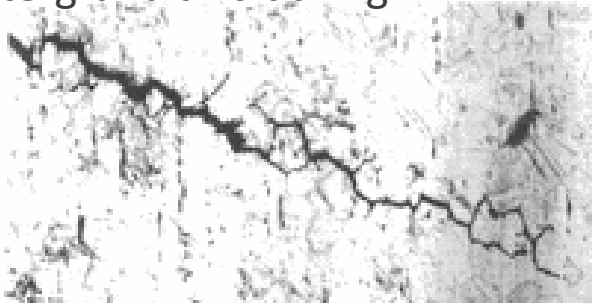

Bolts failure

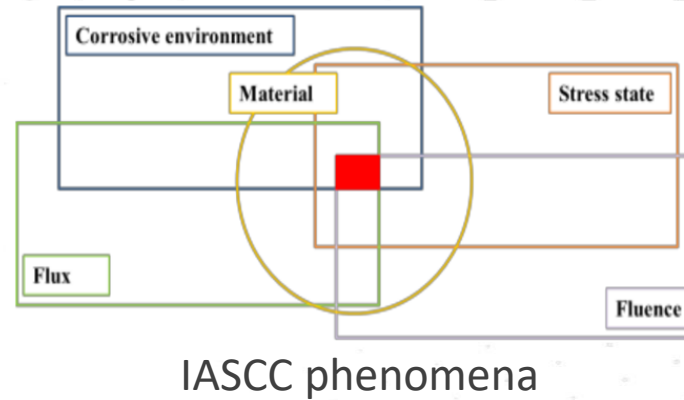
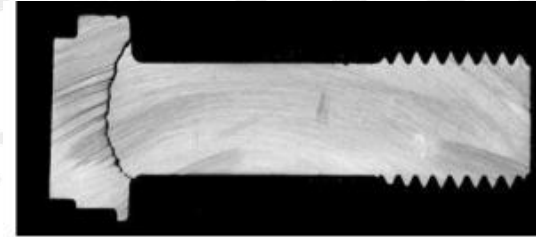

Mostly intergranular cracking

Need to assess GB strength to evaluate IGSCC susceptibility

Definition of an experimental protocol:

- FIB cross-section polishing
- EBSD mapping on cross-section to locate GB
- FIB milling procedure of bi-crystalline micro-beams
- Bending test of micro-beams to access the critical load at failure

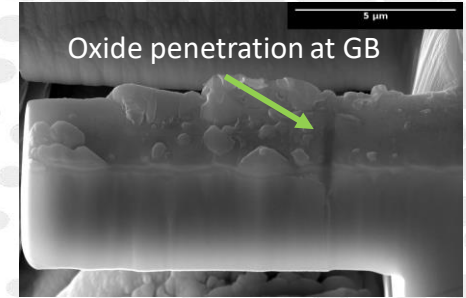

Presentation
focus

Application to model alloy

Application to commercial alloy

FE simulation of micro-bending tests

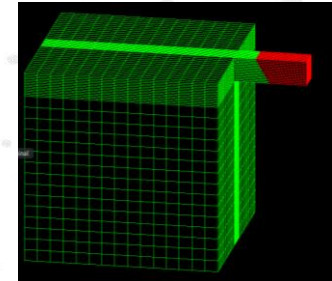

Extract the GB critical stress at failure

Main Si enriched steel chemical elements
(model alloy):

Fe	Cr	Ni	Si
50% wt.	12% wt.	26% wt.	3% wt.

Mean grain size: 10 μ m

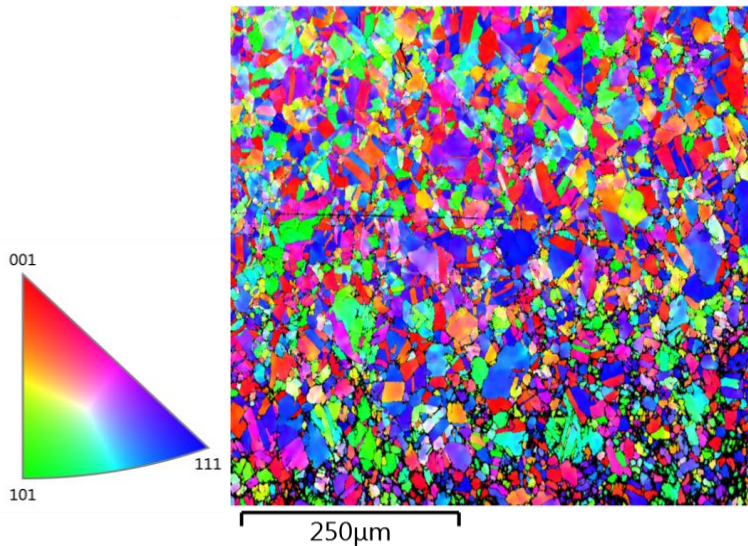

Main 304L steel chemical elements
(commercial alloy):

Fe	Cr	Ni	Mn	Si
70% wt.	18% wt.	8% wt.	1.6% wt.	0.4% wt.

Mean grain size: 21 μ m

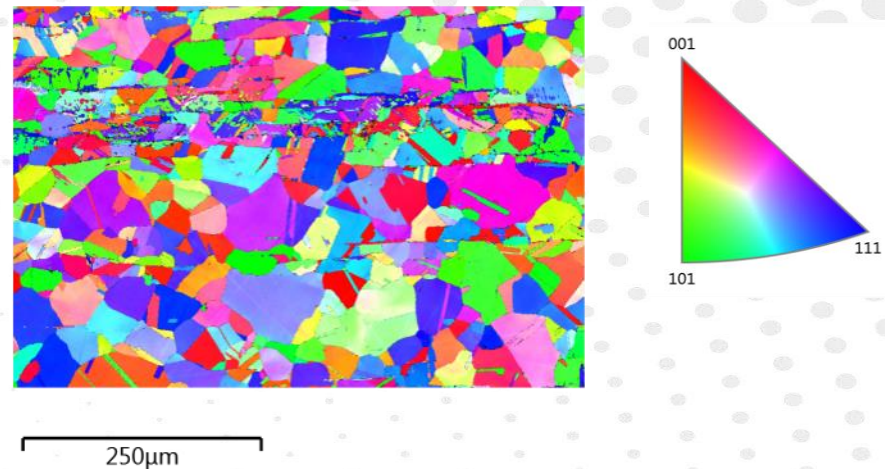

18x2x2mm bar oxidized in PWR environment

Oxidized surface of interest

FIB Ga⁺ ions polishing

Bar cross-section

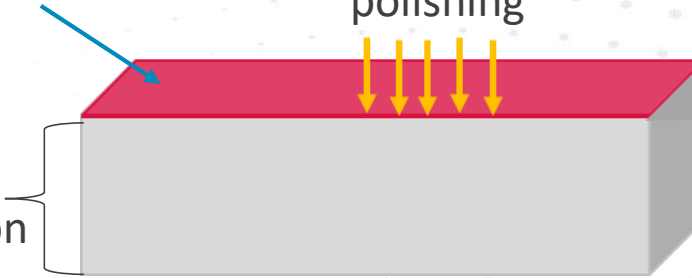

Oxidized surface of interest

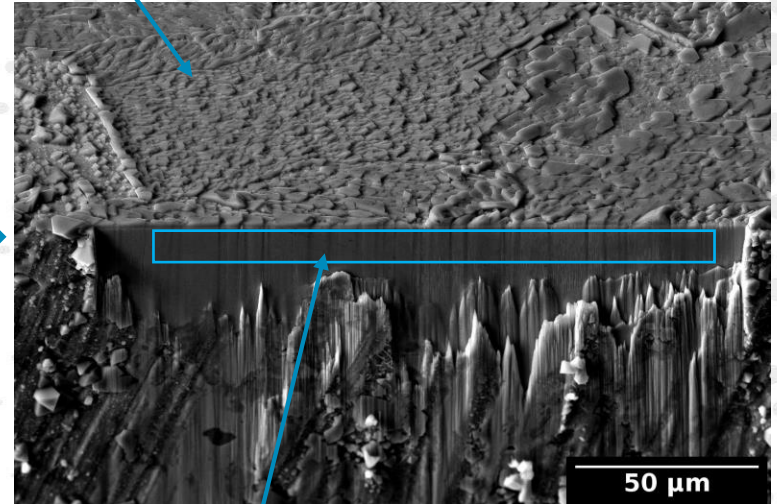

Cross-section polished region for EBSD mapping

Polished cross-section

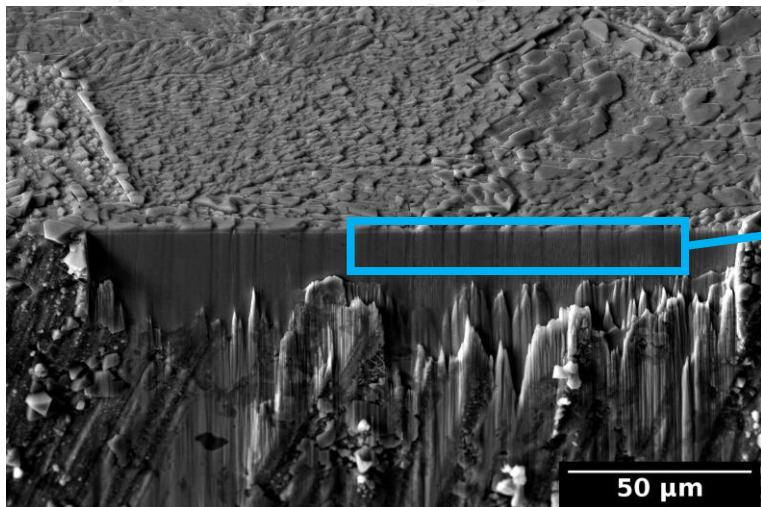

EBSD mapping to locate GB

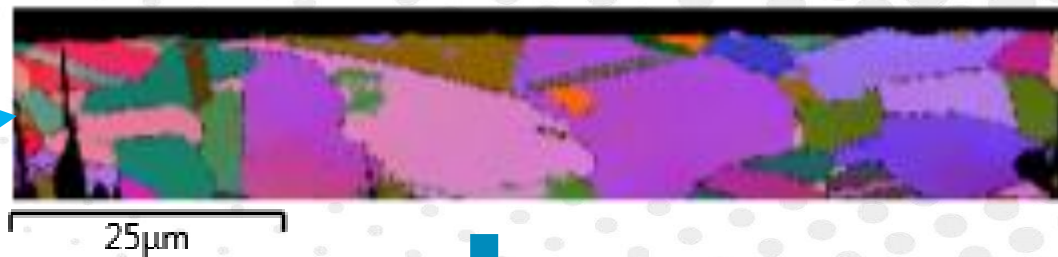

Location of the bi-crystalline micro-beam

2. Study methodology

Milling of 16x5x4 μm micro-beam using SEM-FIB

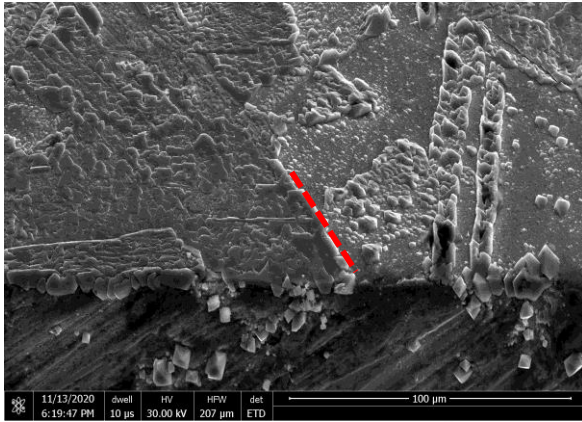

Milling current
21nA
9nA

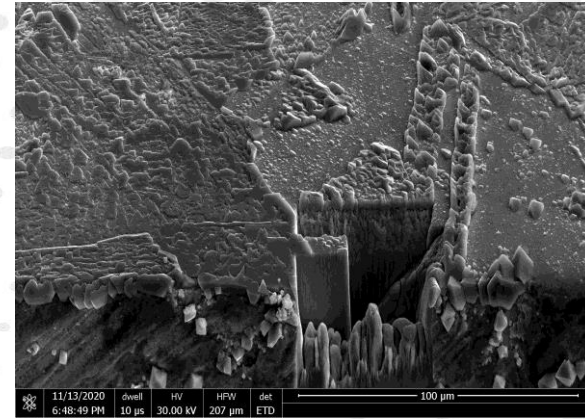

Milling current
21nA
9nA
2nA
1nA

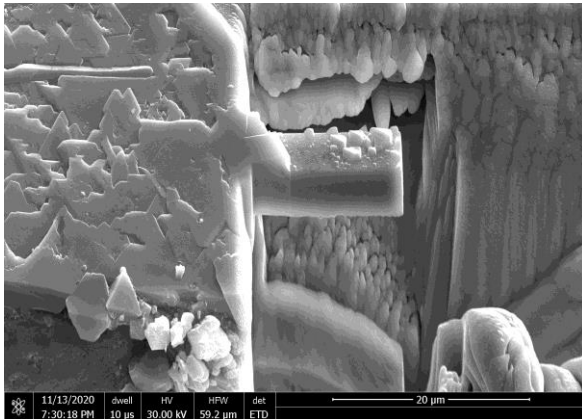

Milling current
2nA
1nA

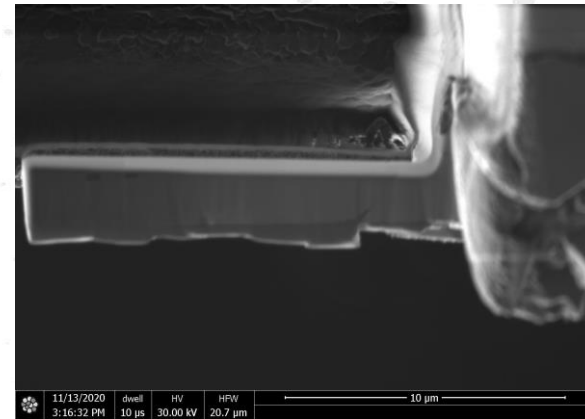

Two axis positioning platform

Sample

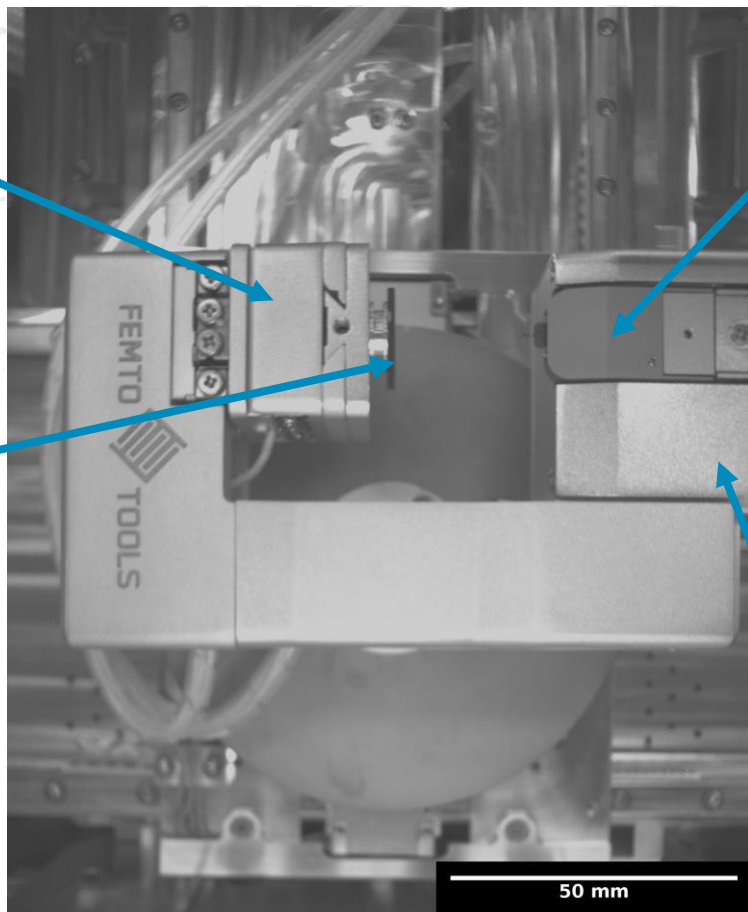

Sensing probe (0.5mN to 200mN) terminated by the Berkovich diamond tip

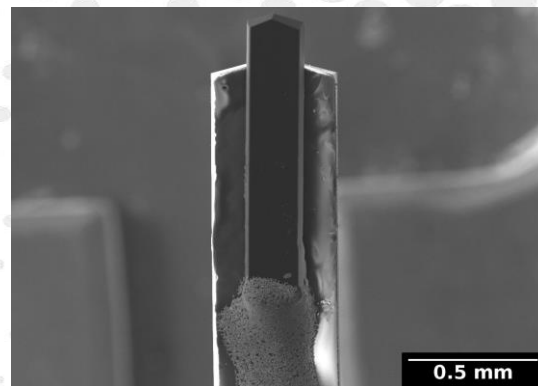

One axis positioning linear piezo scanner

3. Grain boundary strength of Si enriched steel

Oxidation and IGSCC susceptibility

Slow Strain Rate Tensile Test of 40x2x2 μm in PWR simulated environment (4% strain, strain rate $5 \cdot 10^{-8} \text{s}^{-1}$, 300h, σ^{max} 490MPa)

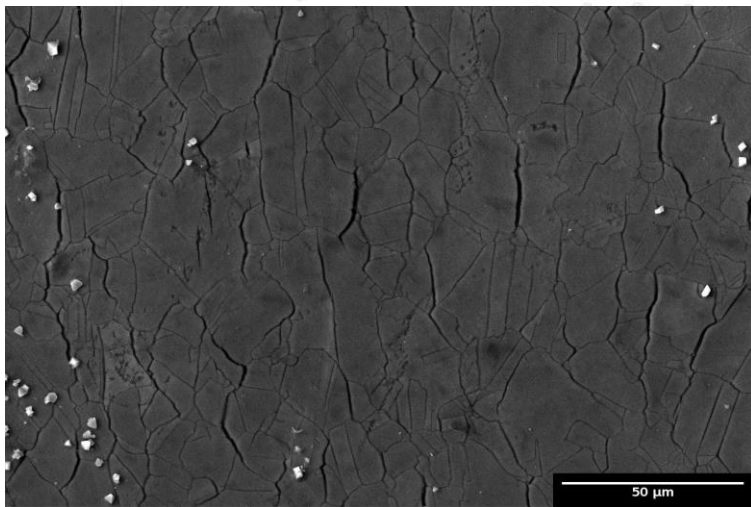

Loading direction

Model alloy susceptibility to IGSCC confirmed

3700h oxidation of 18x2x2 μm sample (340°C, 1000ppm B, 2ppm Li water)

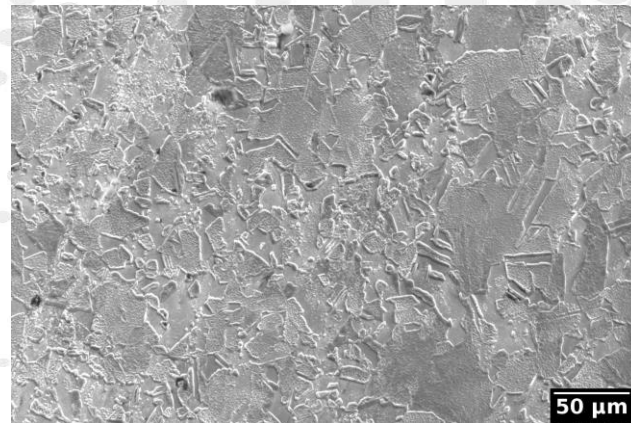

Oxide layer: 2 μm
Oxide penetration at GB: up to 1.7 μm

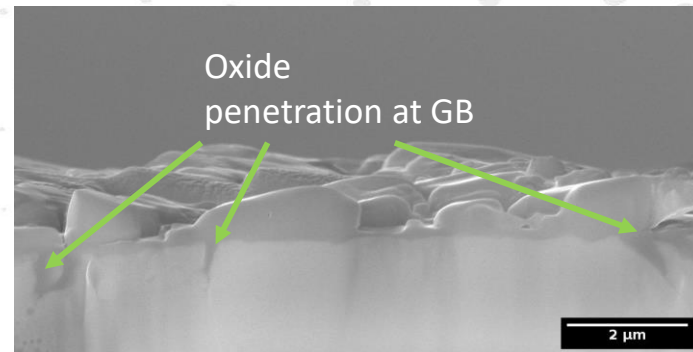

3. Grain boundary strength of Si enriched steel

Micro-bending test

SEM *in-situ* testing of a $16 \times 5 \times 4 \mu\text{m}$ micro-beam at 20nm/s at room temperature

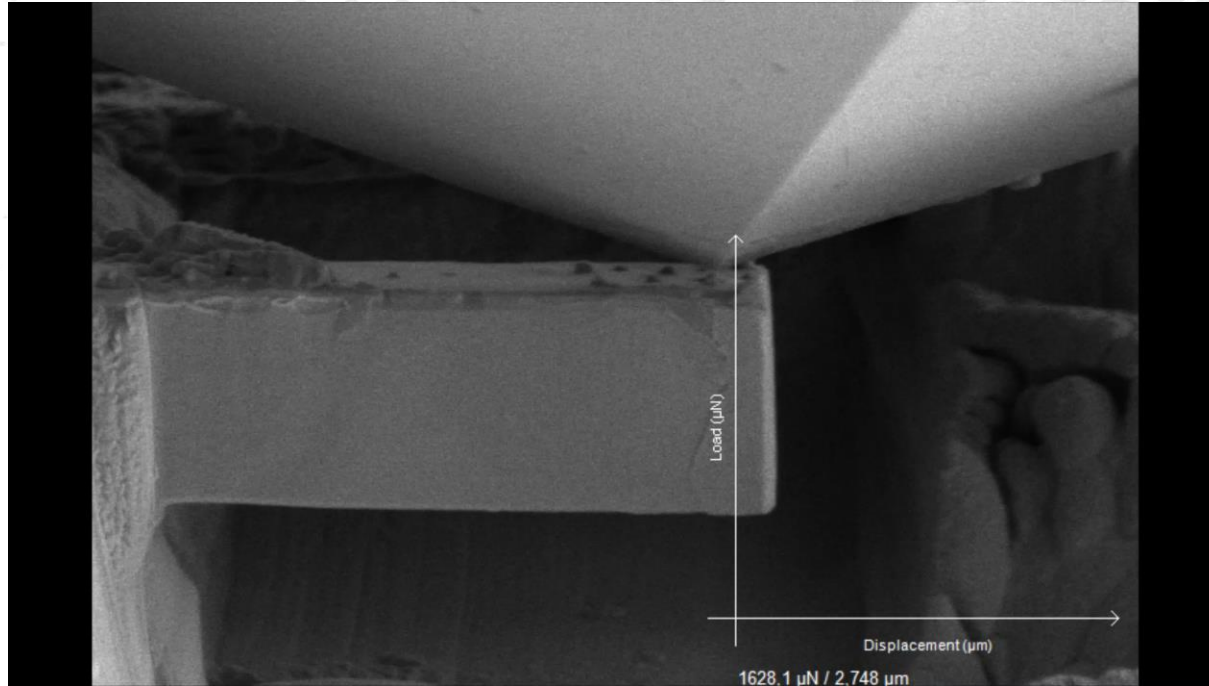

8 micro-bending tests on Si enriched austenitic steel

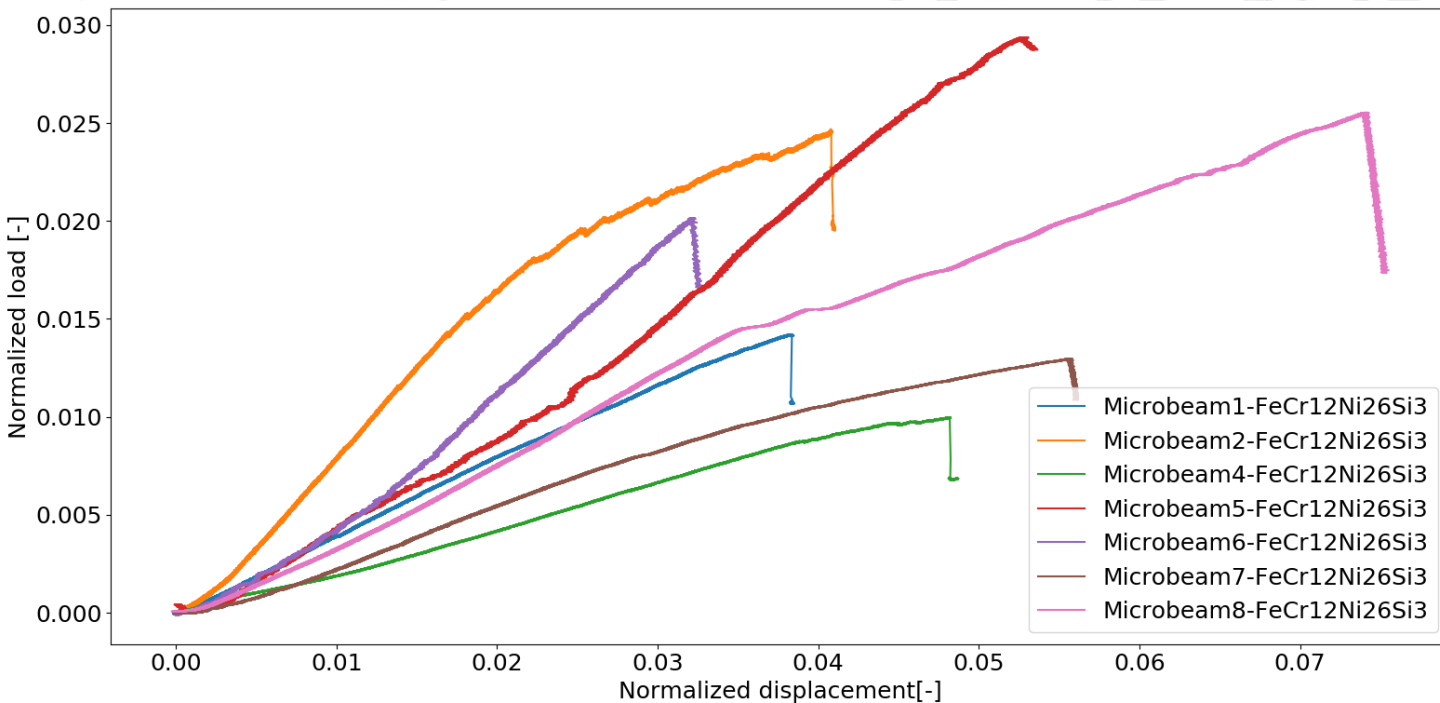

Maximum beam deflection equation

$$d = \frac{PL^3}{6EI}$$

d: beam deflection

P: load

L: beam length

E: Young modulus

I : moment of inertia

Plotted displacement:

$$\frac{d}{L}$$

Plotted load: $\frac{PL^2}{6EI}$

➡ All tested grain boundaries show fragile fracture

Normal GB stress determination

- Estimation of maximum GB stresses using beam theory equations:

$$\sigma_{nn}^{max} = \sigma_{yy}^{max} \cos^2 \theta = 6 \frac{F(L-d)}{bh^2} \cos^2 \theta$$

$$\tau^{max} = \sigma_{xy}^{max} \cos \theta \sin \theta = 6 \frac{F(L-d)}{bh^2} \cos \theta \sin \theta$$

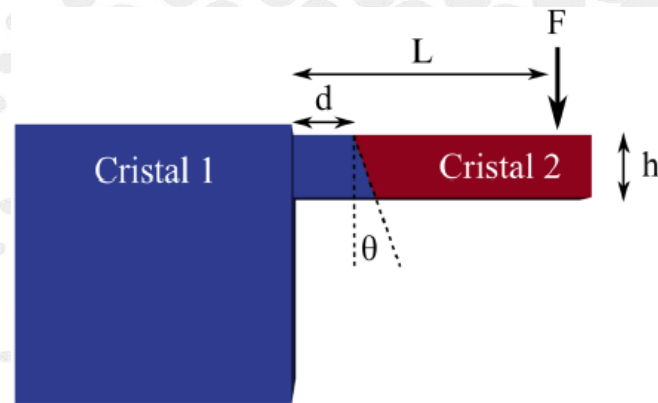

- 3D FE simulations of beam elastic deformation

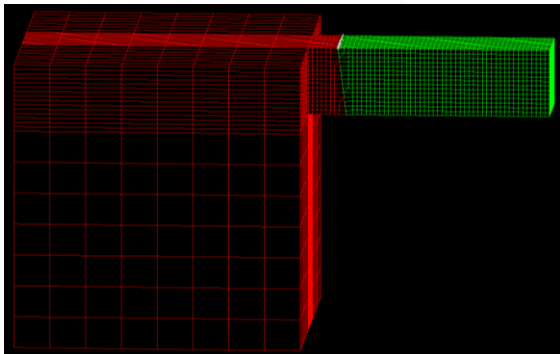

More parameters taken into account

- Crystals orientations
- Indenter tip size and position along beam width



closer to experimental conditions

Evolution of theoretical/simulated GB stress ratio with GB position and GB inclination angle

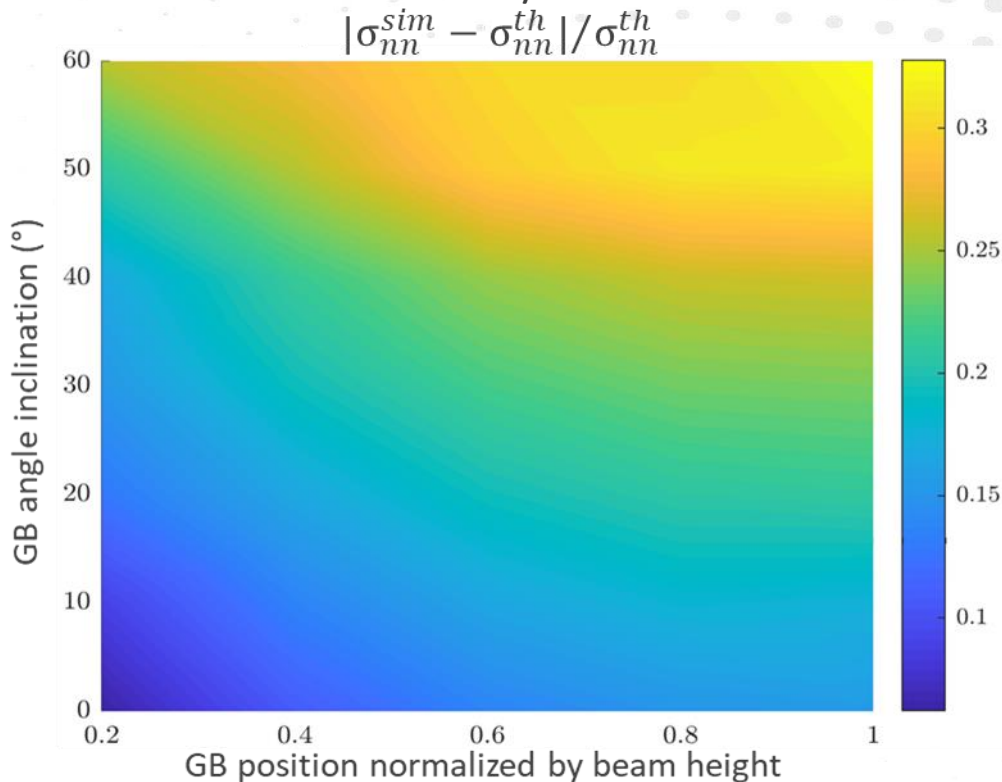

Low ratio between theoretical and simulation GB stresses → GB stress from beam theory equation close the simulation GB stress

→ Beam theory equation can be rely on to estimate the normal GB stress

3. Grain boundary strength of Si enriched steel

Normal GB stress determination

Evolution of normal GB stress at failure with initial crack length

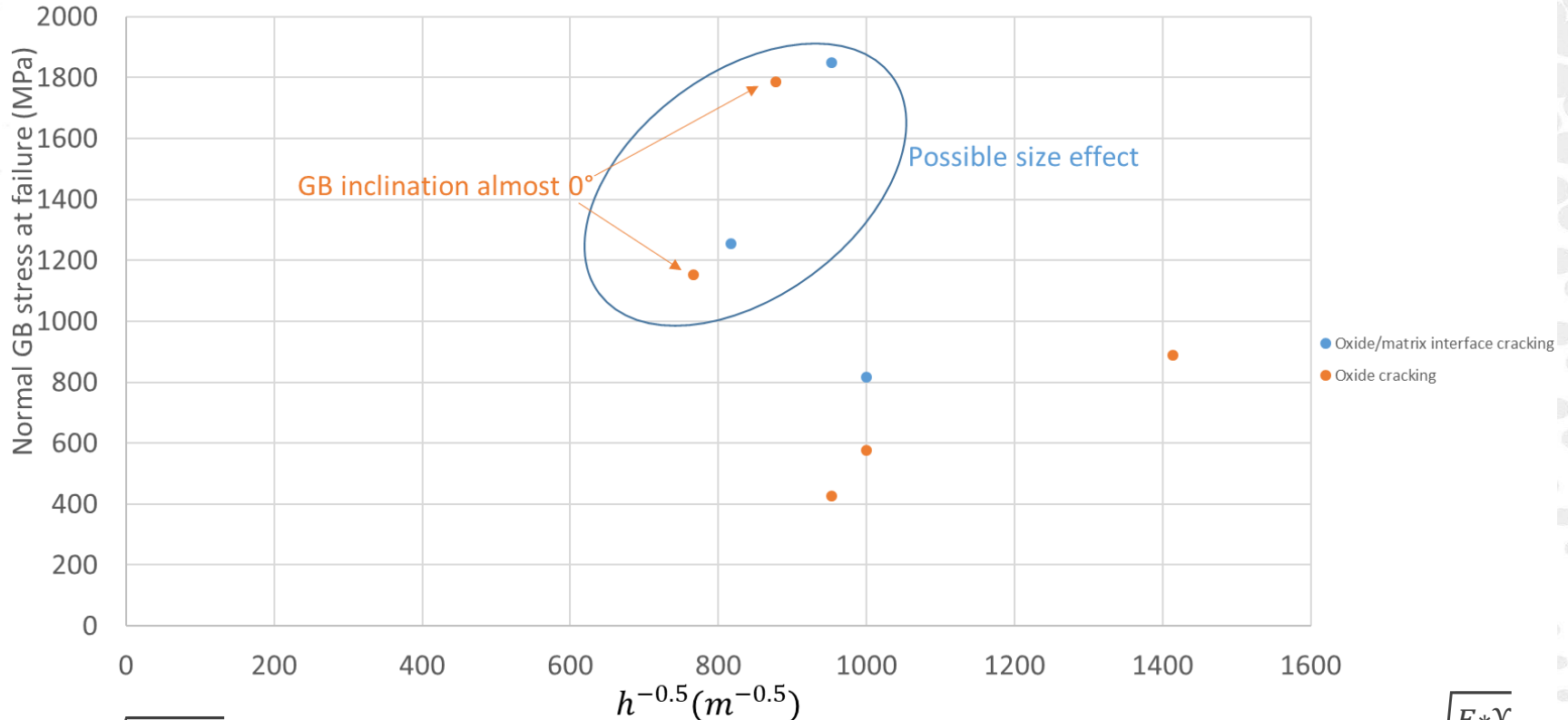

slop = $\sqrt{E * \Upsilon}$: access to the rupture energy according to Griffith model $\sigma_{rupt} \propto \sqrt{\frac{E * \Upsilon}{h}}$

Global trend: higher initial crack length seems to lead to lower normal GB stress at failure

BUT scattering in experimental data:

- Crack occurs either in matrix/oxide interface or inside the oxide (different mechanical properties)
- Oxide thickness on top of GB may increase GB stress at failure → need to be removed

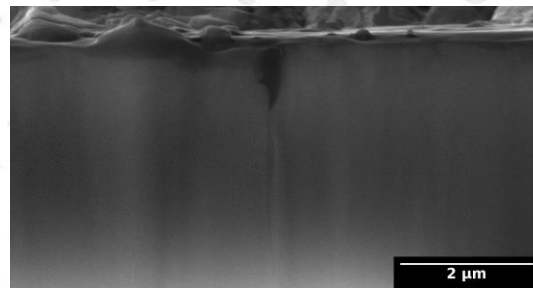
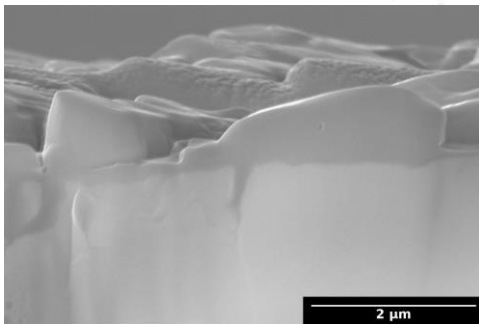

- Different crystalline orientations
- Size effect on mechanical properties (beams heights from 2 μm to 6 μm)

Conclusions:

- Development of an experimental protocol to study intergranular cracking and quantify stress at fracture of oxidized GB in PWR environment
 - Model alloy susceptible to IGSCC
 - Micro-bending of oxidized GB
 - GB stress at failure determination based on combination between analytical equations and FE simulation
- Si enriched austenitic steel shows intergranular cracking after 3700h oxidation in PWR environment
- First results seem to show a decrease of the normal GB stress at failure with the initial crack length but scattering in data calls for further experimentations

Perspectives:

- Application of the experimental protocol to commercial alloy 304L
 - Micro-bending tests on 304L with further oxidation
 - Micro-bending tests on oxidized 304L irradiated with proton at 1dpa
- Improve the modeling experiments to extract GB the stress at failure

SEM *in-situ* testing of a 304L 16x6x7 μm micro-beam at 20nm/s at room temperature

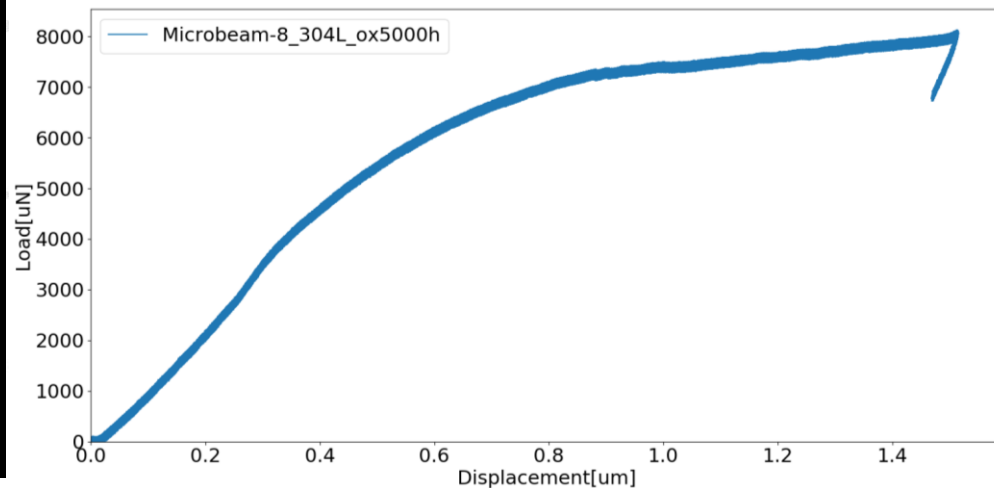

Before testing

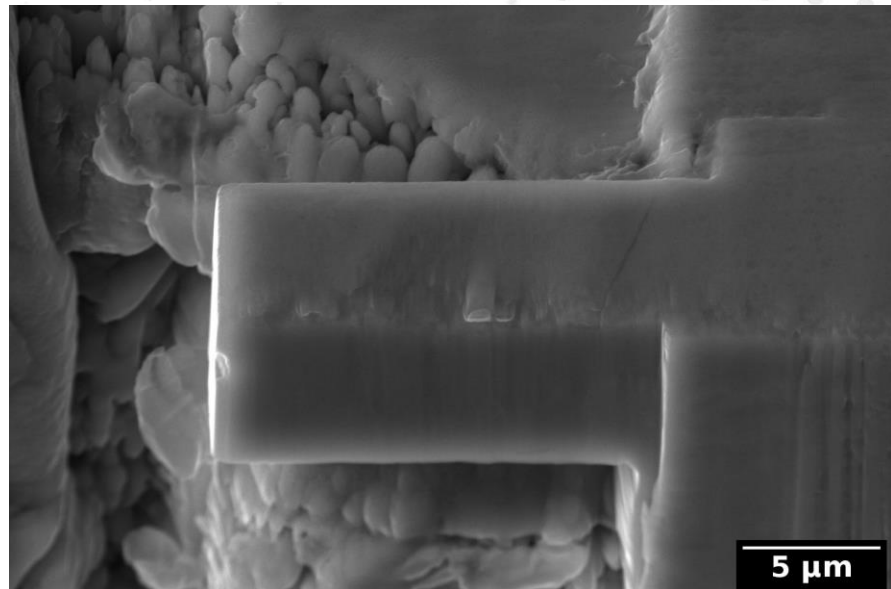

After testing

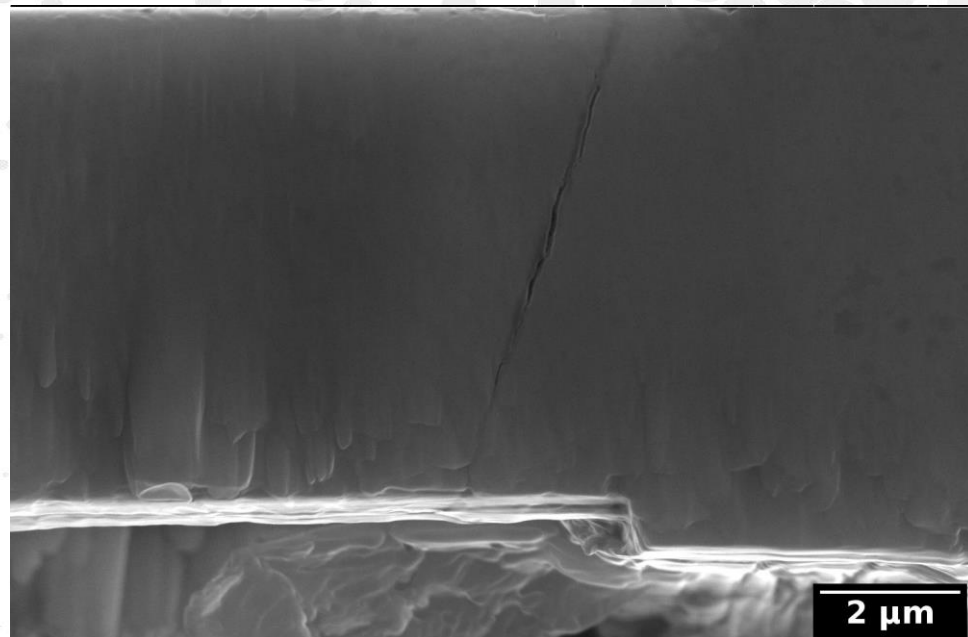

Micro-cracking of an oxidized GB observed on one test (out of 11) → low tendency to GB cracking

→ Need to test more sensible GB (irradiated and oxidized)

Thank you for your attention!
Questions?