

**European Federation Of Corrosion**  
**Working Party 13 – Corrosion in Oil & Gas**

**MOM of the Nice Business Meeting – 10<sup>th</sup> September 2009**

T. Chevrot, Chairman of WP13 opened the meeting at 9 a.m.

**1. ANTIKOR Prize**

This prize, sponsored by ANTIKOR (Russia) was presented by Dr A. Muradov to Christelle Augustin (Vallourec) for the best WP13 presentation by a speaker less than 35 year old during Eurocorr 2009 entitled “A better Control of pH Drift when Testing SSC in Fit For Purpose Conditions”.

Dr. Muradov took the opportunity to give some information about the upcoming Eurocorr 2010 Conference which will be held in Moscow 14<sup>th</sup> to 17<sup>th</sup> September 2010. As the main organizers will be Oil & Gas Companies, the WP13 sessions are anticipated to be very important, both in attendance and in quality. The ANTIKOR sponsored prize will also be a highlight of the conference, with a larger cash sum available for the winner.

With regards to the general organisation of the event, 20 sessions and 4 workshops will be held, and a surprise will be organised during the Gala Dinner. The date and time of the WP13 Business Meeting has not been decided yet, but will be posted on the EFC website before the summer.

**2. General information**

**EFC WP13 website:**

Efforts will be made in 2010 to have a more active and up to date website. The present MOM and related presentations will be available on the website (pending authorization of the speakers), and general information on upcoming events or meetings, as well as progress on current working groups will also be posted.

**Upcoming events:**

SPE 5<sup>th</sup> International Oilfield Corrosion Conference, Aberdeen, 24-25 May 2010

NACE 2010, San Antonio, 15-18 March 2010

Two joint NACE – EFC WP13 meetings will be held during the conference:

- With TEG 374X on “Materials in Oil & Gas”. Chairman: Rich Thompson
- With STG 61 on “Corrosion inhibition”. Chairman: Mohsen Achour

Contributions (presentations) for these meetings will not be published and should be sent to the meeting chairman or alternatively to Thierry Chevrot:

Rich Thompson: [rmth@chevron.com](mailto:rmth@chevron.com)

Mohsen Achour: [mohsen.h.achour@conocophillips.com](mailto:mohsen.h.achour@conocophillips.com)

Thierry Chevrot: [thierry.chevrot@total.com](mailto:thierry.chevrot@total.com)

EFC 16: "Guidelines for Materials Requirements for Carbon and Low Alloy Steels for H<sub>2</sub>S-Containing Environments in Oil and Gas Production", 3<sup>rd</sup> Revision:

Thanks to the hard work of Liane Smith (Intetech Ltd.), the third edition of this important document has now been published and is available at:

<http://www.maney.co.uk/index.php/books>

### **3. Active Working Groups**

CO<sub>2</sub> Corrosion Prediction (A. Palencsar representing R. Nyborg – IFE, Norway)

Following discussions at last year's meeting in Edinburgh, the document "Guidelines for Prediction of CO<sub>2</sub> Corrosion in Oil and Gas Production Systems" was published by IFE and is available at:

<http://www.ife.no/publications/2009/matkor/prediction>

See the attached presentation in Appendix 1.

ISO 21457: "Materials selection and corrosion control for oil and gas production systems" (S. Olsen – Statoil, Norway)

Stein Olsen recalled the general structure of ISO standardization body and its relationships with other organisations such as API. The work is being completed under WG8 of ISO/TC67 (Oil & Gas).

The ambition of the standard is to cover 80% of the needs for materials selection, avoiding issues which are too controversial to quickly publish the document. The driving force for this work is to improve materials' quality and reduce costs by reducing the number of company specific requirements in project specifications.

Coordination with ISO SC4 WG6 and API SC17 was necessary in order to reduce the overlap on materials selection for subsea equipment. This necessitated revising clause 6 of ISO 13628-1.

It is aimed to issue the FDIS version of ISO 21457 at the end of 2010.

Stein also presented the contents of the future ISO 21457. See the attached presentation in Appendix 2.

"Guidelines for material compatibility and corrosion testing to qualify workover and completion fluids" (S. Nodland – Statoil, Norway)

The objective of this work is to propose a methodology for testing / selecting brines depending on completion materials. The process is in two stages: Screening test by the supplier and Qualification test jointly between supplier and end user. See the attached presentation in Appendix 3.

The draft issue has been completed and is being circulated for review by interested members. The aim is to publish the document early 2011.

“Recommended Practice for Corrosion Management of Pipelines in Oil & Gas Production and Transportation” (B. Kermani – Keytech, UK)

The first meeting of the working group took place on 11-12 June, 2009 in Paris. It was agreed to produce a “Recommended Practice” document, which will include some minimum requirements to ensure the fundamental basics are followed when managing corrosion in pipelines. Wording of specific paragraphs will therefore have to be carefully chosen. The contents of the document were defined, and a high level table of contents was produced. See the attached presentation in Appendix 4.

Following discussions during the meeting, it was agreed that the working group should include a list of exclusions in the document, so that the type of pipelines covered is very clear.

The aim is to publish the document end of 2011, after a draft has been circulated to interested members for review.

“Four Point Bend Testing” (S. Bond – TWI, UK)

This was discussed for the first time at the last meeting in Edinburgh and has been re-discussed during NACE 2009 in Atlanta as NACE TM0177 is also dealing with the subject.

Stuart highlighted some of the problems of the 4 point bend test for pipeline girth welds, which may lead to either under-conservative or over-conservative conclusions. Following this, some technology gaps which need to be addressed further were listed such as specimen preparation, protocol for the use of strain gauging, orientation of specimen from girth welds, influence of weldment root, loading of CRAs, etc.

Stuart also presented some comments already received from various participants and some findings from TWI. See the attached presentation in Appendix 5.

Stuart Bond will collect further comments (in particular, further information following work done by Exova will be available soon) and propose a draft text for NACE 2010 in San Antonio, for discussion at NACE TM0177 meeting.

Progress will also be presented at the joint NACE TEG 374X / EFC WP13 meeting in San Antonio.

#### **4. Technical presentations**

“An improved approach to pitting resistance of CRAs” (S. Bond / C. Lee – TWI, UK)

The work recently started and sponsored by BP, ENI, & UK HSE aims at developing a simple test method for reliably assessing CRA materials pitting resistance in autoclaves in the presence of CO<sub>2</sub> and H<sub>2</sub>S. This includes the definition of adequate acceptance criteria. In particular, current monitoring was used to detect the onset of stable pitting and a maximum current of 5 µA/cm<sup>2</sup> is proposed as an acceptance criteria. See the attached presentation in Appendix 6.

The work will now be extended to a wider range of environments and materials relevant to oil & gas production. There are also plans to combine the pitting monitoring with SCC/SSC 4 point bend testing and corrosion fatigue testing.

“The effect of sigma phase in duplex stainless steels on corrosion properties” (S. Olsen – Statoil, Norway)

Major deficiencies during the manufacturing of duplex stainless steel fittings (poorly controlled heat treatment) have been occurring since 2006 and have affected a large but unknown number of fittings. About 22% of the fittings inspected in the field have shown the presence of sigma phase, and one project recently replaced 7,400 fittings.

Although sigma phase is known to affect both mechanical properties (toughness) and corrosion resistance of duplex stainless steels, generic data on these effects is still very difficult to obtain, and may not always be relevant to oil & gas production. See the attached presentation in Appendix 7.

Discussions during the meeting reinforced that the amount of sigma phase will considerably reduce resistance to H<sub>2</sub>S cracking, and will also lower the critical temperature for SCC to occur in marine atmosphere.

There was also mention of a number of papers published on the subject.

Statoil is launching an experimental programme on the subject and will welcome participation from other interested parties.

“On the beneficial influence of a very low supply of H<sub>2</sub>S on the hydrogen embrittlement resistance of carbon steel wires in flexible pipe annulus” (Carol Taravel-Condât – Technip, France)

This very comprehensive presentation outlined the specific corrosive environments present in flexible pipes' annulus as well as their favourable impact on hydrogen embrittlement of Carbon steel wires. The low H<sub>2</sub>S flow rates compared with the steel surface area (highly confined environment) lead to a decrease in the environment severity and to a reduction of HIC damage. Some HIC tests results were presented and the impact of these beneficial effects on flexible design was mentioned. See the attached presentation in Appendix 8.

There was no other business and the meeting was closed at 12:00.

# **APPENDIX 1**

# Status on CO<sub>2</sub> corrosion prediction document

Rolf Nyborg

Institute for Energy Technology

21.01.2010



# Document for corrosion prediction

- Joint industry projects at IFE 1998 - 2009
  - Evaluation of CO<sub>2</sub> corrosion models and collection of field data
- An operators' group for preparation of a document with guidelines for CO<sub>2</sub> corrosion prediction was formed in parallel with the IFE joint industry projects
  - 10 meetings in 2003 – 2009
- Draft document submitted to EFC in 2006 for consideration as an EFC document
- Decided at WP13 meeting in Freiburg in 2007 not to publish as an EFC document, partly due to commerciality issues



# Guidelines for CO<sub>2</sub> corrosion prediction

- Methodology for corrosion prediction based on severity classes
- Listing and short description with references of all models which have been evaluated in the IFE Joint Industry Projects
- Choice of model left to the user
- Decided to publish as an open IFE report
- Now posted on IFE's website for free download: [www.ife.no](http://www.ife.no)
- <http://www.ife.no/publications/2009/matkor/prediction>
- Further info: contact Rolf Nyborg, [rolf@ife.no](mailto:rolf@ife.no)

## **APPENDIX 2**

# Progress on ISO standard 21457

Stein Olsen StatoilHydro

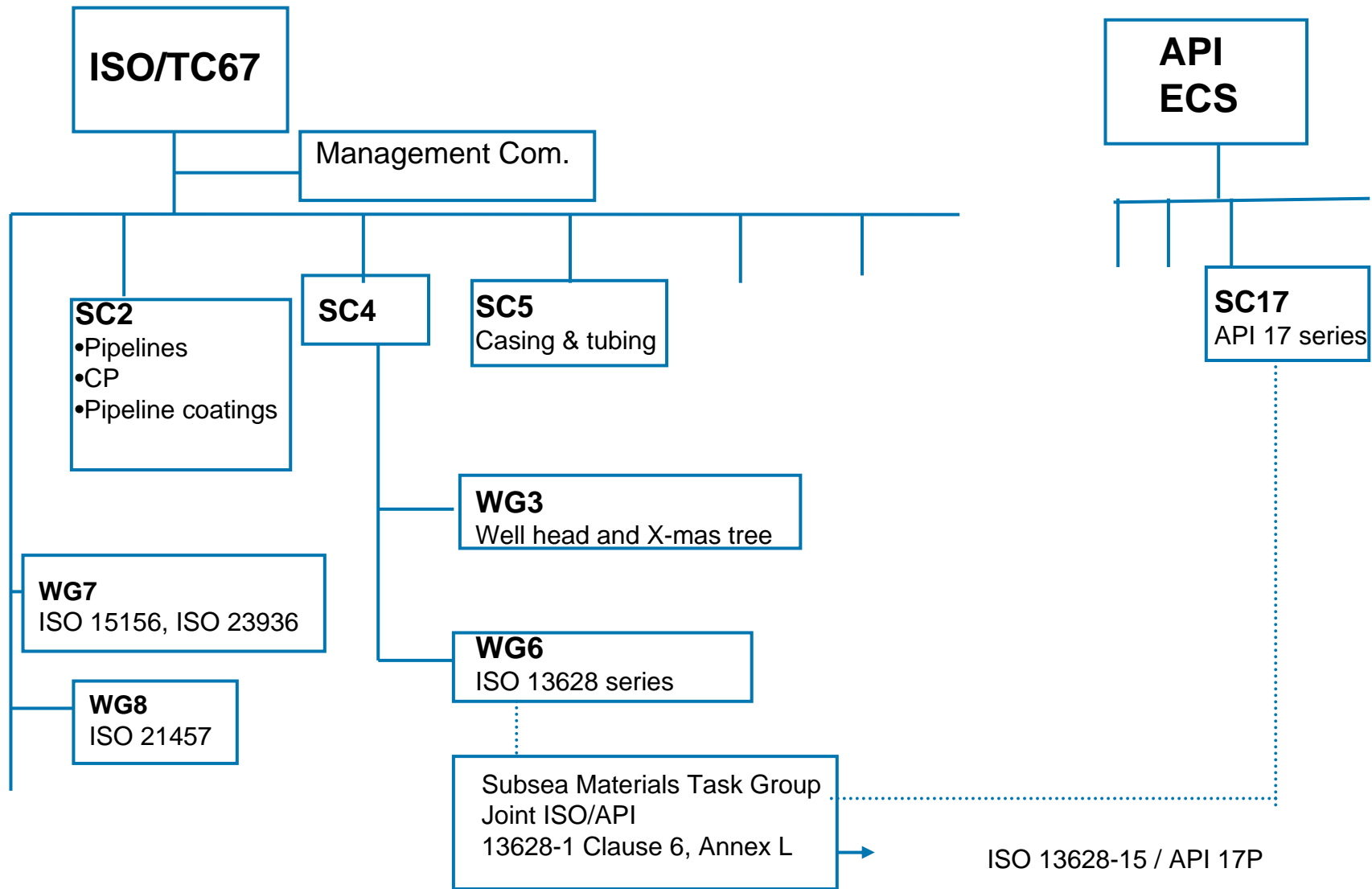

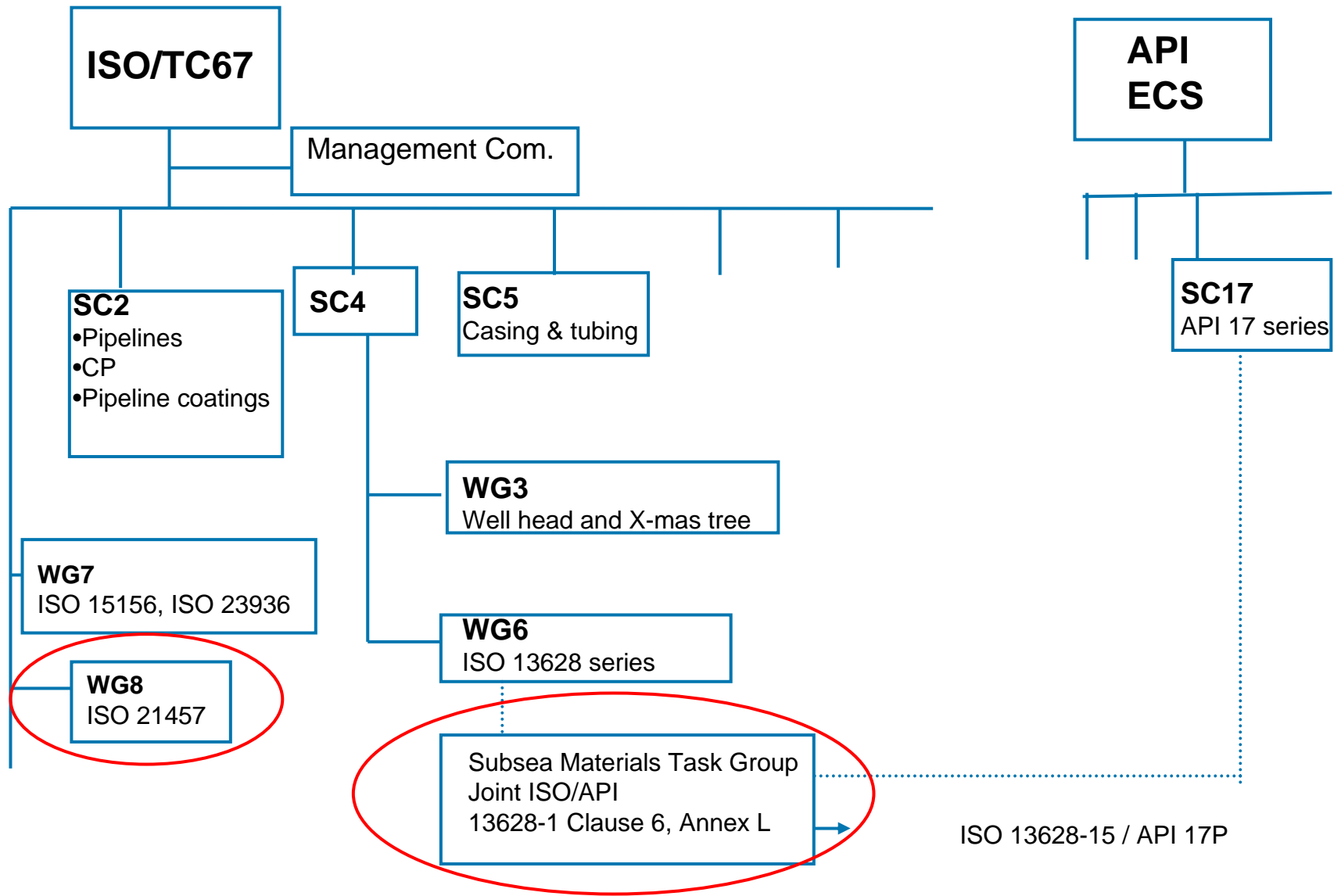

## **ISO 21457 ” Materials selection and corrosion control for oil and gas production systems ”**

- General Materials Requirements Standards
  - ISO 21457 Materials selection and corrosion control
  - ISO 15156 Materials for use in H<sub>2</sub>S-containing environments
  - ISO 23936 Non-metallic Materials
- Materials requirements in ISO Product standards (priority)
  - ISO 13628 suit of standards (Flexible pipes, Manifolds etc.)
  - ISO 3183 Pipelines
  - ISO 10423 Wellhead and Christmas tree equipment
  - ISO 15589 Cathodic Protection
  - +++

## **ISO 21457 ” *Materials selection and corrosion control for oil and gas production systems* ”**

- Improve quality and save cost
  - Less material requirements in company and projects specifications.
  - More predictable situation for suppliers, manufacturers and contractors
  - Less manhours used in projects
- The ambition is to cover as much as possible (80%) of normal needs with respect to materials selection in ISO 21457.

## Harmonization with ISO 13628-1 Clause 6

- Subsea Materials Task Group (ISO SC4 WG6/API SC17)
  - Revised Clause 6 on Materials selection
    - Originally overlapping ISO 21457
    - Harmonized and minimised overlap (CP, fasteners)
    - FDIS planned fall 2009
  - New Annex L on Fabrication of manifolds
    - Decided to be moved to ISO 13625-15 / API 17P
    - Technically where it belongs, but
    - Publication delayed 6-12 months



## Contents of ISO 21457

- Materials selection report
- General guidelines on corrosion evaluations and materials selection
  - What are the relevant mechanisms
  - What are the actual models and relevant parameters
- Materials selection for specific applications and/or systems
  - Tables with typical materials for wellhead equipment, piping, valves, pumps and vessels
  - Covers production systems, injection systems and utility systems
  - Lists temperature limits for relevant materials in seawater systems and for external SCC of CRAs

## Contents of ISO 21457

- Corrosion control
  - Inhibitors
  - Coatings, splash zone protection
  - CP
  - Closed compartments
  - Fasteners
  - Sealing materials

## Relevant corrosion mechanisms for internal corrosion/cracking

| Corrosion mechanism                            | Carbon and low alloy steel | CRA |
|--|----------------------------|-----|
| CO <sub>2</sub> and H <sub>2</sub> S corrosion | x                          | xa  |
| Corrosion erosion                              | x                          | —   |
| MIC  | x                          | x   |
| Corrosion fatigue                              | x                          | x   |
| H <sub>2</sub> S cracking                      | x                          | x   |
| HIC/SWC  | x                          | —   |
| ASCC   | x                          | —   |
| SCC  |                            | x   |

a The presence of H<sub>2</sub>S in combination with CO<sub>2</sub> can also lead to localized attacks on CRAs. The critical parameters are temperature, chloride content, pH and partial pressure of H<sub>2</sub>S. There are no generally accepted limits and the limits vary with type of CRA.

## Temperature limits

| Material type  | Grade     | Maximum operating temperature limits a, b<br>° C |
|--|-----------|--|
| Austenitic SS  | Type 316  | 50 to 60   |
|  | Type 6Mo  | 100 to 120                                       |
| Duplex SS  | Type 22Cr | 80 to 100  |
|  | Type 25Cr | 90 to 110  |
| <p>a The materials may be used at higher maximum operating temperatures at marine installations within areas with full HVAC control.</p> <p>b Nickel-based and titanium alloys do not have established temperature limits in marine environments, but are recognized to be more resistant than stainless steels.</p> |           |  |

## Injection systems

- Water injection
  - Dearated seawater
  - Aerated seawater (chlorinated, untreated)
  - Produced water re-injection
  - Aquifer water injection
  - Combinations
- Gas injection (Dry, wet)

## Typical materials

| Equipment   |  | Materials  |
|---|--|--|
| Wellhead equipment/Xmas trees   |  | Carbon or low alloy steel with Alloy 625 overlay covering seal areas and other fluid-wetted areas, depending on the fluid corrosivity; type 13Cr steel with/without Alloy 625 overlay at sealing surfaces            |
| Piping  |  | Carbon steel or low alloy steel with or without CRA clad; type 22Cr duplex; type 25Cr duplex; type 6Mo; type 316   |
| Valve body/bonnets  |  | Carbon steel or low alloy steel; carbon steel with or without CRA weld overlay; type 22Cr duplex; type 25Cr duplex; type 6Mo; type 316   |
| Valve internals   | Surface installations and subsea retrievable | Type 13Cr steel or alloys with better corrosion resistance than the body   |
|   | Subsea installations non-retrievable         | Alloy 718 or alloys with equivalent or better corrosion resistance than the body   |
| Vessels   |  | Carbon steel with and without internal organic coating or lining a<br>Carbon steel with CRA clad or weld overlay such as type 316, alloy 904, alloy 825 or alloy 625<br>Type 316, type 22Cr duplex, type 25Cr duplex |
| <p>a Sacrificial anodes may be required for pressure vessels made of carbon steel with internal coating or lining. The requirement for regular inspection and coating repairs should be accounted for in materials selection.</p> |  |  |

## Schedule for ISO 15156

- DIS was sent out for international hearing and voting in June 2009.
- Comments will probably be received in November
- Next meeting in the expert group will take place January 2010
  - FDIS will be prepared
- Planned distribution of the FDIS is summer 2010
- Final voting is expected to be finalized fall 2010 and the standard could be issued by the end of 2010.

## **APPENDIX 3**



## **Guidelines for material compatibility and corrosion testing to qualify workover and completion fluids**

WP13 meeting, 9. September 2009

## Introduction

- Operators have a need for a unified test approach for oilfield brines
- Oilfield brines defined as:
  - Completion, Drilling and Workover Fluids
- The test method shall:
  - enable fair comparison between brines
  - ensure that all corrosion risks are known before use
- A document has been produced by a group of Operators:
  - BP, ENI, Total, Shell, StatoilHydro
- Test document has been sent to major brine suppliers for comments

## Status

- An EFC WG was established in 2008. Members are:
  - Stale Nodland, chairman, (StatoilHydro)
  - John Martin (BP)
  - Tiziana Cheldi/Lucia Torri (ENI)
  - Ed Wade (Consultant)
  - Mohen Achour (ConocoPhillips)
  - Thierry Cassagne (Total)
  - Siv Howard (Cabot Specialty Fluids)

## Two stages of testing

- **Screening test**, to be performed by brine supplier
  - PURPOSE: Verify stability of chemicals at relevant temperatures and avoid chemical breakdown and unwanted corrosion
- **Qualification test**, to be performed together with end user
  - PURPOSE: Establish the suitability of the brine for a specific environment and materials
- Two test environments included in both stages;
  - N<sub>2</sub>/inert atmosphere
  - actual CO<sub>2</sub>/H<sub>2</sub>S atmosphere (H<sub>2</sub>S may be omitted in screening test)

## Screening test - by supplier

- Separate thermal stability test for 90 days
- "low-tech" corrosion tests, 30 days;
  - weight loss, U-bends and tensile specimens
- Use of generic/typical materials and operational parameters
- Proposed materials are:
  - Low alloy steel (110ksi preferred)
  - 13Cr (typically L80)
  - SMSS 13Cr (typically 13Cr/5Ni/2Mo, 110 ksi preferred)
  - 25Cr superduplex (125 ksi preferred)
  - Super-austenitic 28 Cr (125 ksi preferred)
  - Ni alloys (Alloy 718, 125 ksi preferred)

## Qualification testing – supplier together with end user

- Corrosion testing from screening test is modified as follows;
- Operational parameters and material selections are field specific
- Duration is 30 days for halides, 60 days for organic salt based brines
- Corrosion tests include SSC/SCC testing, either;
  - 4PB, C-ring or Constant Load.
  - DCB is an option if end user agrees
- Crevice corrosion tests may be included
- Hydrogen samples for measuring H-uptake in metals

## Suggested acceptance criteria (not mandatory)

- Chemical stability;
  - (No) chemical degradation (pH and chemical analysis)
  - No significant change in pressure
- Corrosion tests;
  - $< 0.025$  mm/yr (1mpy) for CRAs
  - No pitting or cracking
  - No loss in ductility on tensile samples
- In addition for qualification test:
  - No crevice corrosion
  - Acceptable hydrogen uptake

## What's next?

- Working Group members will finish draft issue
- Draft issue is sent on extended hearing
- All hearing comments to be compiled and answered by WG
- Final issue will be issued as EFC document
- The Operators will use EFC doc as a requirement to suppliers
- This will in time provide test results which will enable a fair comparison of products
- Corrosion risks may then be evaluated objectively and reduced.
  
- Do you want to receive a copy? Let me know on [stano@statoilhydro.com](mailto:stano@statoilhydro.com)



## **APPENDIX 4**

## **EFC WP 13; Corrosion in Oil & Gas**

# **WG: Corrosion Management of Pipelines; An update**

---

Presentation Extracted from:

MOM 1, Paris Meeting, 11<sup>th</sup>-12<sup>th</sup> June 2009



**TOTAL**

# Participants at the first meeting

---

- **George Winning**                      **Ionik / JP Kenny**
- **Alan Crossland**                      **BP**
- **Bernt Slogvik**                         **StatoilHydro**
- **Helen Sirnes**                         **StatoilHydro**
- **Carol Taravel Condat**                **Technip**
- **Elias Remita**                         **Technip**
- **Bijan Kermani**                        **KeyTech**
- **Sergio Kapusta**                       **Shell**
- **Helga Stangeland**                    **TOTAL E&P Norway**
- **Thierry Chevrot**                      **TOTAL E&P**

**Objectives, procedures & means**

## Objectives: Producing a reference document

---

- To compile useful information across the industry with regards to corrosion management of pipelines
- To define common requirements between Oil & Gas operators and design houses to:
  - Ease discussions with projects' partners worldwide,
  - Deal with 3<sup>rd</sup> parties tie-ins
- To agree with design houses on processes to be followed to define corrosion management requirements
- To show the authorities that the industry is treating the issue seriously and to provide basis for future standards if needed

***Nothing similar is available today;  
the industry must anticipate future needs***

# The procedure

---

## By maximising the use of existing standards

- **Taking advantage of work already carried out by EFC, ISO, NACE etc. organisations when possible:**
  - Simplification of the work to be achieved,
  - Avoids contradicting existing standards,
  - Will ease the publication of a future ISO standard (if necessary)
  - But needs to avoid using standards tightly linked to local legislation (UK, US,...?)
- **Including the work of experts in specialised technical areas**
- **Providing a bridging document:**
  - One document referring to (some) available standards in the industry,
  - To provide a logical link between these standards,
  - To fill in the gaps for a fully integrated corrosion management of pipelines.

## Means & organisation of the work

---

- WP16 has proposed to help by dealing with cathodic protection aspects
- Leadership remains with WP13
- NACE will be informed on progress as it is trying to produce a similar document (but tightly related to local legislation)
- Each member of the working group will be responsible for drafting assigned parts of the document
- Draft reviewed by all working group members,
- Draft submitted to EFC WP 13 for review & comments

**Aim for publication: 2011**





## Type of document

---

- Guidelines ?
- **Recommended practice**
- Minimum requirements ?
- Best practice ?
- State of the art ?

It is agreed to produce a “Recommended Practice” document, which will include some *minimum requirements* to ensure the fundamental basics are followed when managing corrosion in pipelines. Wording of specific paragraphs will therefore have to be carefully chosen.

## Scope and coverage

---

- **Rigid & flexible pipelines**
- **E&P effluents only including export lines (dry gas & oil)**
  - Including injection and/or produced water
  - Not service lines
  - Not hydrocarbon refined products
- **Onshore & offshore**
- **Corrosion management from design to decommissioning**
- **Title:**

***Recommended Practice for Corrosion Management of Pipelines in Oil & Gas Production and Transportation***

# Detailed scope

---

- **This document is:**
  - a recommended practice (RP) that covers the management of corrosion for pipelines carrying hydrocarbons, injection water and / or produced water, from design to decommissioning
- **The RP does not replace statutory requirements, minimum requirements, or regulations of the operating regions**
- **In this document, a pipeline is defined as:**
  - a line which carries fluids from wellheads or production sites to process sites (including platforms, reception plants, and downstream facilities) and vice versa, excluding wells, vessels, rotating equipment and process pipework
- **This document follows the logical steps of a basic corrosion management process (i.e. assessment, mitigating measures, design and implementation, monitoring and inspection, review and change) and makes references to relevant International Standards and / or Recommended Practices when available.**
- **This RM is intended for use by personnel from the Oil & Gas Industry having basic knowledge of corrosion & materials.**

# Definitions

---

- **Corrosion management includes:**
  - Identification of corrosion threats, corrosion assessment, selection of internal & external corrosion mitigating actions (materials selection, chemical treatments, coatings, CP, process conditions,...), implementation of mitigation actions (process data and operating conditions collection & analysis), corrosion monitoring, inspection, remedial works, sourcing of adequate human resources, and managing performance of the system to reduce the corrosion threats to acceptable levels. These activities constitute an input to the development and execution of integrity management and Risk Based Inspection.
- **Pipeline:**
  - As defined earlier
- **Risk Based Inspection: (standard definition will be used)**
- **Integrity Management: (standard definition will be used)**
- **Inspection: (standard definition will be used)**
- **Monitoring: (definition will be used)**
- **Performance management: (definition will be used)**



# Structure of the document

---

## high level Table of Contents

- **The document will be structured according to a usual and basic corrosion management practice (although some companies may use more sophisticated models).**
- **The chapters are therefore defined as in the schematic on the next slide, which was agreed during the meeting**
- **Each chapter was reviewed to start detailing its contents, still at a high level**

# Structure of the document

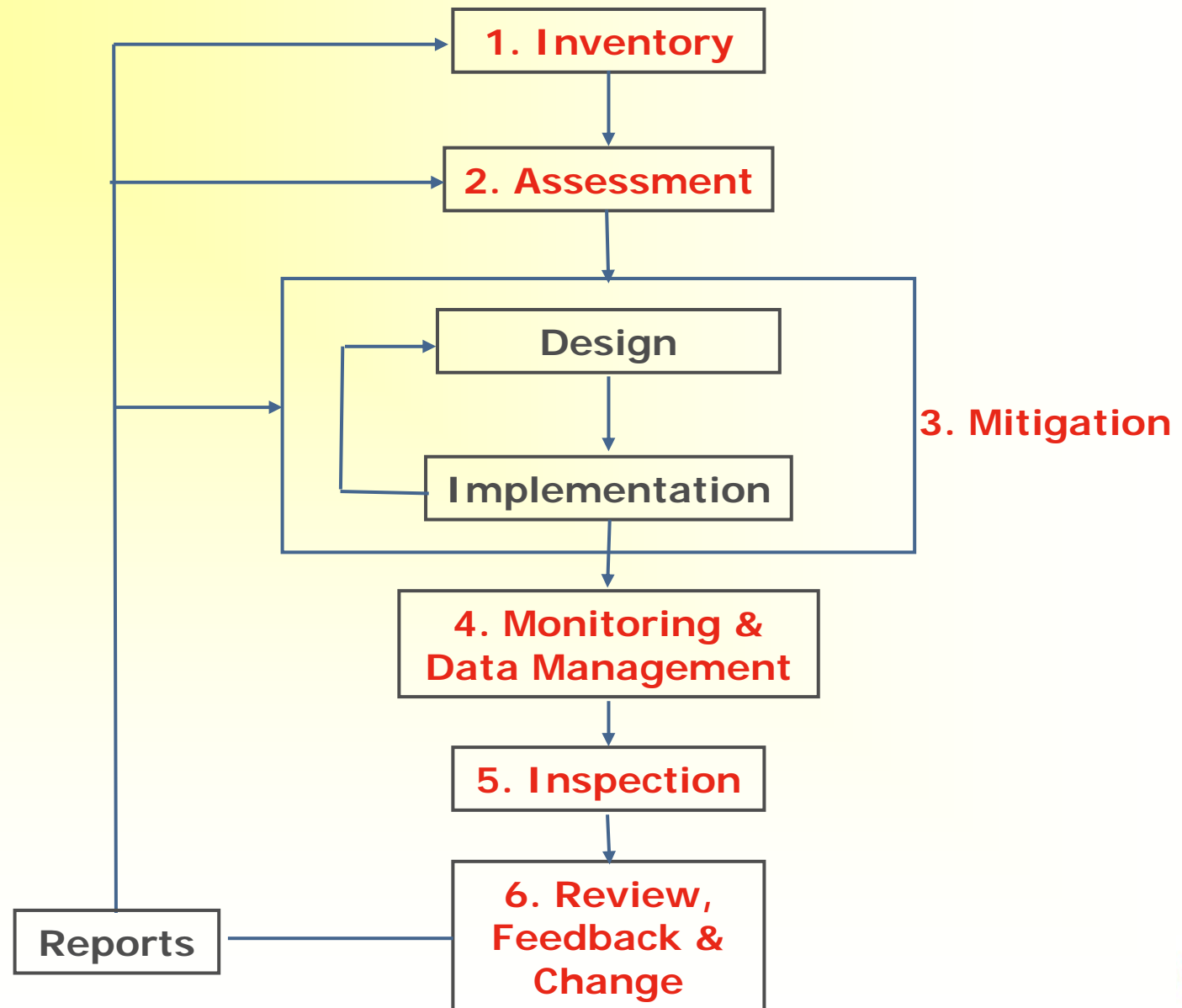

# Chapter 0:

---

## Introduction

- **Benefits of corrosion management of pipelines**
- **Management commitment**
  - Responsibilities / accountabilities
  - Corrosion management policy
- **Balancing corrosion rates from models with mitigation, feedback & experience.**
- **Competency of personnel**



# Chapter 1:

## Inventory of hardware and/or basic design data required for corrosion assessment

- **Inventory of the “hardware”, i.e. list of pipelines to be protected with basic information data.**
- **To be considered:**
  - Pipe ID, internal diameter, WT & length, material
  - Age and / or design life
  - Maximum operating conditions (T & P)
  - Fluid types (gas, oil, condensate, water) & throughputs
  - Onshore, offshore, both
  - External environments (soil data, arctic, desertic, deep water,...)
  - Type (flexible, rigid)
  - Internal and/or external coatings

**Thierry Chevrot in charge**



# Chapter 2:

## Corrosion assessment

- **Gathering data inputs Alan Crossland in charge**
  - Fluid chemistry
  - Gas compositions (CO<sub>2</sub>, H<sub>2</sub>S, O<sub>2</sub>, Organics,...)
  - Flow regime
  - Existing 3<sup>rd</sup> party activities & infrastructures relevant to potential corrosion threats (CP facilities, stray currents, tie ins, upstream processes,...)
- **Existing mitigation systems (in case of existing line) George Winning in charge**
- **Competency level requirements Sergio Kapusta / Alan Crossland in charge**
- **Relevant corrosion threats Sergio Kapusta in charge**
- **Evaluating severity/magnitude of corrosion threats. Bijan Kermani in charge**
  - Models
  - Operating experience
  - Both

# Chapter 3:

## Mitigation actions

- **Design / selection**
  - Material
  - Corrosion allowance
  - Internal & external coatings
  - Chemical treatments
  - Cathodic Protection
  - Operational pigging
  - Competency level requirement
- **Implementation**
  - Competency level requirement
  - Operating window / future trends
  - Procedures
  - Monitoring / follow up technical feasibility
  - Equipment requirements / location / logistics
  - Resources (HR, equipment,...)
  - Setting KPIs

**George Winning in charge**

# Chapter 4:

## Monitoring & data gathering

- **Hardware**

- Inventory of corrosion mitigation equipment (CP, injection pumps,...)
- Inventory of corrosion monitoring equipment (typical, process monitoring,...)
- Inventory of minimum chemicals quantities required

- **Methods**

- Procedures
- Data acquisition, trending, & analysis (operational, injection rates, CP, coupons...)
- Laboratory analysis (water chemistry,...)
- Chemicals quantities purchases

- **Organisational**

- Ownership (hardware, software,...) → Responsibility / accountability matrix
- Competency level requirements
- Relevant data management
- Reporting

**Helen Sirnes & Bernt Slogvik in charge**

# Chapter 5:

---

## Inspection

- **Introduction: Use of Inspection in Corrosion Management**

- Anomaly Tracking
- Verification of Monitoring data

- **Hardware / Methods**

- Cross reference to other relevant standards guidance
- Temporary / permanent pig launchers & receivers for ILI
- Type of ILI tool
- UT mats and UT scans

- **Methods**

- ILI
- Direct assessment (NACE Document)
- ROV
- CIPS/DCGV Cathodic protection

**Alan Crossland in charge**

# Chapter 6:

## Review, Feedback, & change

- **Document corrosion assessment, mitigation, monitoring, inspection, analysis, and evaluation**
  - Who ?
  - How ?
  - How often ?
- **Reporting**
  - who?
  - How ?
  - how often ?
- **Decision making**
  - Who?
  - How ?
- **Act & follow up**

**Person in charge to be decided**

## Throughout the document

---

- **The special case of flexible pipes will be considered throughout the document.**
- **A generic corrosion assessment needs to be performed according to the methodology of the document to identify any problems or shortfalls.**

**Carole Taravel Condat & Elias Remita in charge**

**Next meeting;  
week of 9 November, London**

**All contributions and comments are welcomed**

**Contact: Bijan Kermani or Thierry Chevrot**



## **APPENDIX 5**

# *WP13 Work Group on “Four Point Bend Issues”*

**Stuart Bond**  
stuart.bond@twi.co.uk

+44 1223 899 000

TWI Ltd, UK



# *4PB Method – Active Participants*

- Two focal points addressing the subject:
  - NACE TM0177 – inclusion of 4pb method into the standard (Chris Fowler plus NACE Members)
  - EFC Working Party 13 ad hoc work group
  - Stuart Bond, Christoph Bosch, Thierry Cassagne, Brian Chambers, Chris Fowler, Stein Olsen, Alan Turnbull, Shuji Hashizumi, Masakatsu Ueda and Marc Wilms
  - All are involved in both NACE and WP13 thus streamlining issues and resolution for initial incorporation in EFC 16 & 17, (cited by ISO15156/MR0175) and then into TM0177
  - We welcome further comments and input!

# Overview

- 4pb method has been cited in EFC 16 and 17 since 1<sup>st</sup> editions in 1990s for testing SSC/SCC resistance in sour service
- ISO15156/MR0175 cites EFC 16 & 17 for guidance on 4pb as a preferred test method since 2003
- An established method but concerns expressed over need to harmonize approaches so more precise guidance can be incorporated within TM0177
- Initial issues presented at joint NACE/EFC session at Corrosion2009 Atlanta March 2009

# *Typical Constant Deflection Jigs*



**Specimen 210L x 25W x 10T mm**

# *Typical 4pb application*

- Constant deflection
  - Easy to set up, but care needed, strain gauging is recommended
  - Allows multiple specimens to be run simultaneously, especially in autoclave testing
- Constant load
  - Overcomes creep relaxation of specimens
  - Can be “dead weight” lever arm, or, more sophisticated (hydraulic with load control)
  - Not so easy to use in autoclaves for multiple specimens
  - Can be adapted for in-situ plastic strain?

# *4pb for Pipeline Girth Welds*

- It is NOT a sophisticated, refined test
- It is Conservative
  - Useful for highlighting *potential* problems
  - Must ensure it is not unconservative
  - Must ensure it is not overly conservative
- Not appropriate to refine test excessively

# *Under- & Over-Conservative Issues*

- Under-conservative:
  - Pass criterion based only upon visual examination (even at low magnification) are insufficient
  - Loading by deflection
  - Constant load (dead weight loading) preferable?
- Over-conservative
  - Machining cap to reduce thickness
    - Exacerbates misalignment effects
    - Test full thickness wherever possible



# *Issues – Initial Questions*

- What technology gaps need to be bridged?
- General issues
  - E.g. Dimensions of specimens, selection of material to maximise wall thickness in testing, use of strain gauging and protocol for their use.
- Testing weldments
  - E.g. Orientation of specimen from girth welds; all testing appears to be transverse to the weldment. Has anyone used the orientation as shown in EFC16 to extract specimens longitudinal to the weldment?
  - Retention of weldment root intact; is this your normal procedure for example when testing weldments?
  - For CRA what procedure do you use in terms of consideration of tensile properties at elevated temperature of test, and application of load (allow some relaxation and then reapply etc?). Do you use constant deflection jigs or constant load?

# *Specific comments received*

- Christoph Bosch - Salzgitter Mannesmann
- Adam Rubin – NKT Flexibles
- Alan Turnball – NPL

# *Christoph Bosch – Specimen Size*

- Standard machined specimen size:
  - 115-140x15x5 mm (L x W x T) to ISO 3183
  - Test labs are using different specimen geometries successfully for years. Recommend only limited range of specimen sizes in a new document.
  - Reduced sample length 60(70)x15x5 mm allows testing transverse specimens from smaller diameter pipes.
  - Appropriate for longitudinal sampling of girth weld, depending on pipe dimensions. Note: failure occurs in the HAZ. Testing longitudinal welds with longitudinal specimens (without base metal and HAZ) never showed any failure so far.
  
- Full-size specimen size:
  - 260x25xwall thickness CORROSION 2004, paper 04130
  - Experience that full-size specimen results are comparable in pass/fail behaviour to machined specimen (140x15x5 mm), also in weld position (transverse).
  - Heavy wall large-diameter pipes need sampling especially weld (root / cap) with machined specimens. Can test full-size specimens as an alternative.
  - Full-size specimens: higher costs and test efforts (lab capacity, solution volume, strain gauging). However: stress distribution at stressed 4PB specimen surface very close to reality in pressurised pipe (FEM calculation)

# *Christoph Bosch - Stressing*

- Sampling positions:
  - Base metal: transverse or parallel to rolling direction/pipe axis (not an issue)
  - Weld metal: transverse to weld
- Specimen stressing according to ASTM G39, is comparable to strain gauges when using flat machined specimens on base material and weld specimens (transverse).
- Strain gauges: higher costs and test efforts. Is it worth the effort?
- Stress: 0.2 % plastic strain from uniaxial test useful to keep comparability to NACE TM0177 method A tests, which are sometimes required in tests parallel to 4PB to assess threshold stresses.

# *Adam Rubin - Stressing*

- Uniaxial stressing (NACE TM 0177) vs. 4-point bend stressing
  - Stress pattern in a specimen exposed to uniaxial loading is different from the stress pattern in a 4-point bend specimen.
  - Can't expect 100% convergence in results between the two loading methods.
  - Experienced that materials which consistently developed HIC type damage (not SSC failure) in four point bend testing was absolutely free of internal cracks in similar test where only difference was change of loading to uniaxial stressing.

# *Adam Rubin – Flexible Wires*

- Validated ASTM G39 for rectangular specimens with strain gauge measurements on high strength carbon steel wires
- Non-welded samples: calibration curves from typically 5 specimens with strain gauges, deflected in 4pb in 10 steps to yield point monitoring at each step and correlating to ASTM G39. Excellent correlation
- For non-welded samples do not mount strain gauge on test specimens, but load based on the formula and the validation load curve.
- Can also be used for wires with a non-rectangular cross-section (for instance C-shaped profiles).
- Welded samples are wires with flash butt welds. Prefer to test welds in uniaxial tension, since we then load the entire cross section of the weld.
- If welds are tested in 4pb, found deviation between stress and deflection larger than for non-welded samples. In consequence for welded samples we always mount strain gauges on each specimen.

# *Alan Turnball - Loading*

- Alan Turnball, NPL comments on loading:
  - I still feel that we should be loading to 0.2% plastic strain as determined under bend, and using that and the force-strain curve under bend, to determine the corresponding total strain and deflection.
  - It seems to me fundamental since after all we are testing under bend and not under uniaxial strain.
  - In our experience the difference between our approach and the approach of using the total strain from a uniaxial stress-strain test and deflecting to that value can be significant (up to 20% or so) or very small depending on the alloy and the thickness of the specimen.
  - Intuitively, the thicker the specimen the smaller the stress gradient in the bend specimen and the more likely that the two approaches will give closer agreement.

# Alan Turnball – Loading CRA

- NPL recommend load at ambient temperature to achieve the ambient temperature 0.2% proof stress under bend as monitored by strain gauge and then fix the deflection
- Each specimen if we accept the need to strain gauge each weld specimen
- On raising the temperature to test value the deflection is fixed and so the load will relax from A to B in Figure 1. The specimen is now overstrained (Conservative, Alan's preference)

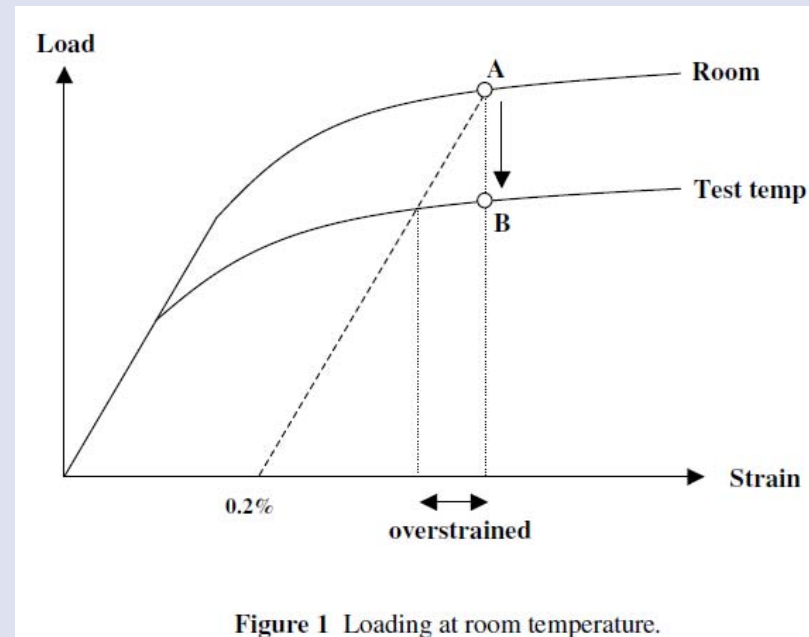



# Alan Turnball – Loading CRA 2

- Using a calibration specimen (parent plate or weld specimen as appropriate) load the specimen at the test temperature (position B in Figure 3). Note the displacement/deflection required. Then, at *ambient* temperature, load all subsequent specimens to this deflection
- Assumes that we will achieve the same strain level despite possible variations in weld characteristics from specimen to specimen; actual strains will be unknown and may be greater or less than 0.2% value; load will initially be high (A in Figure 3) before relaxing to final value. (Meets ISO15156 guidance)

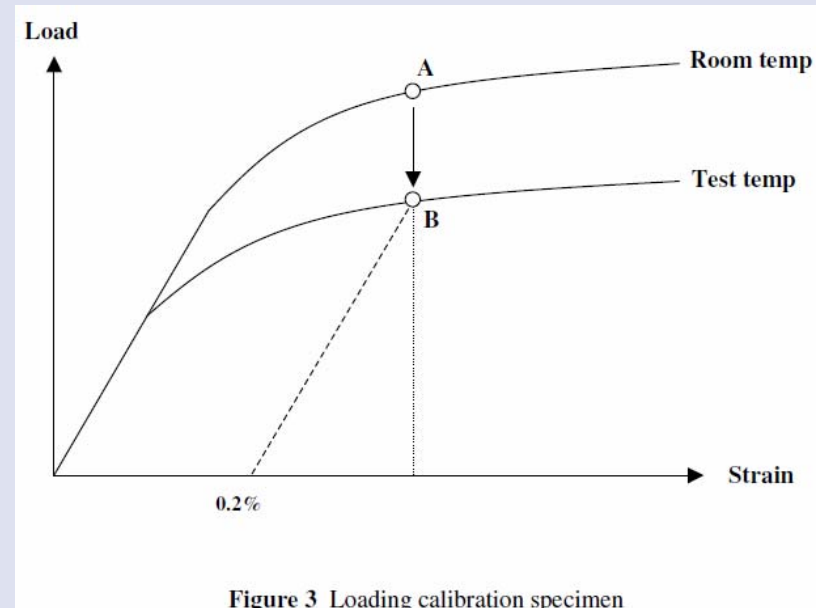

# *Alan Turnball – Additional Comments*

- Misalignment either side of the weld and the allowable step as you note. Since the back-face is usually machined off this creates a difference in thickness. Our FE analysis shows that this has the effect of the test transforming almost to a 3 pt bend test with maximum stress offset. See Corrosion Engineering, Science and Technology Vol40, 2,pp103-109; we used thin specimens and recommended testing full thickness.
- The other feature we noticed (as did Sytze) was the sensitivity to weld root profile with the height/sharpness of protrusion being important. This led to us taking photos for reference - it is an issue when reflecting on the number of tests that should be done for a weld. We initially advocated 5 (in one case we had only one in 5 fail from the same pipe section) but the industry was more comfortable with 3.

# *Other Concerns - Relaxation*

- Corrosion-resistant alloys require testing under environments simulating service
  - Elevated temperature
  - Elevated pressure
- Relaxation may lead to reduced stress during testing under constant-deflection
  - Not considered a problem for C-steels

# *TWI Findings*

- For 4pb testing CRA
  - No significant thermal stresses between specimen and loading jig
  - Curvature from pipe can give 10% variation in stress across specimen
  - Misalignment of 1.5mm can lead to increased stress at weld root
  - For 316L relaxation over 90hrs can reduce stress by 60MPa

# Summary - 1

- Views on specimen size recommendation
  - Limit variation so test labs have consistent specimens to test?
  - Avoid specification of standardised specimen size. Rather, advise on ratio between jig size and specimen size. In addition specification for some widely used specimens can be given, for instance pipe wall sections?
  - Use full wall thickness where feasible, or, minimise machining to retain “thick” specimens?
- Surface Finish
  - Test specimens with degreased as-received finish for the given product, including welds for qualification in a simulated operation environment.
  - For ranking of materials and for comparison purposes, standardised surface finish can be applied
  - Characterise degree of misalignment either side of weld and also root protrusion profile (former can be measured but latter will require photo in section)

# Summary - 2

- Views on initial loading/stressing
  - Debate on use of bend data for total strain value?
  - Calibration curves for parent materials
  - Strain gauge welded specimens (compression side calibrated to tensile side to retain HAZ heat tint etc)
  - Concerns by some that strain gauging increases costs but may not lead to benefit – this needs debate!
- Comparison with full-scale tests
  - Full-scale testing of pipe in 10-12” under 4pb with environment in the bore is straight forward
  - Can this be used to give improved confidence in small-scale testing just as it is being used to assist in confidence in  $K_{ISSC}$  for fracture mechanics (ECA) in sour service?

# *Summary - 3*

- **Maintaining Load/Stress**
  - How should we advise on this issue?
  - Constant load with load cell (straight forward for C-steels, not for CRA)
  - Calibration to consider relaxation at test conditions, can we provide reference data at different temperatures?
  - Can't rely upon strain gauges in situ due to undercut of adhesive etc (can do so on full-scale or full-ring test externally)
- **Duration of test for CRA**
  - Is 720hrs sufficient for initiation?
- **Evaluation**
  - Does pitting of CRA constitute failure?
  - Insist on metallographic sectioning and examination?

# *Technology Gaps - Refinements*

- Environment
  - Chemistry – service simulation?
  - Temperature – colder than RT for some materials, elevated for CRA?
- Load
  - Must strain gauge deflection specimens?
  - Distribution of strain and consideration of relaxation?
  - Need to understand UT vs bend load response?
- Orientation
  - Load is hoop stress in girth welds, but transverse in test; significant?
  - Extraction of specimens from clad systems; masking of substrate?
- Post-test examination requires sectioning and microscope examination
- CRAs
  - Crack initiation period; use electrochemical techniques?
  - Assessment of pits and initiation locations of cracks?
- Comparison of 4pb with full-scale performance of welds for confidence?



# *Next Steps*

- Further contribution or additional comments?
  - E-mail Stuart Bond [stuart.bond@twi.co.uk](mailto:stuart.bond@twi.co.uk)
- SB to then collate all comments in a short document on the above themes for review by work group including gap identification
- Draft text for discussion in San Antonio NACE Corrosion2010 (TG299, EFC/NACE joint session or at TM0177 meeting; which is preferred?)

## **APPENDIX 6**

**TWI**

## An Improved Method of Pitting Testing of CRA



**Chi Lee**

**TWI Ltd**

**[chi.lee@twi.co.uk](mailto:chi.lee@twi.co.uk)**

**+44 1223 899 000**



World Centre for Materials Joining Technology

Copyright © 2009, TWI Ltd

# *Background*

- New developments require optimised CRA selection
- Solid or clad material options
- Welds require qualification
  - SSC / EAC performance
  - Localised corrosion performance data not available in cases where EAC is not expected
  - Hence autoclave tests

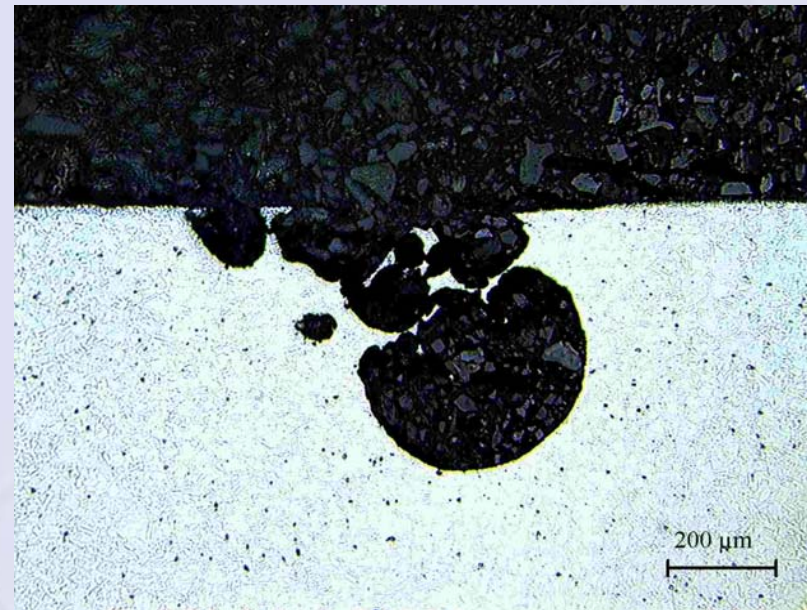

# *Background 2*

- PREN is not satisfactory for prediction
- Laboratory testing required to meet project development schedule (max 1 month?)
- If pitting is observed in lab qualification, how is it assessed?
  - “Zero” pitting criteria, impacts upon project materials cost
  - If “some” pitting is acceptable, no general criteria available to assess
  - No in-situ measurement, hence no knowledge of pit initiation, propagation or re-passivation
  - Relationship to service performance?

# *Benefits*

- Development of pitting acceptance criteria will allow:
  - Optimised materials selection & weld qualification
  - Rational basis to compare performance of different materials or material performance in different environments.
- Development of a standard test method will allow:
  - Reliable qualification tests to be undertaken worldwide, e.g. close to fabrication sites thus minimising time required for qualification

# *Objectives*

- To define a simplified standard method for autoclave material selection (qualification) testing of CRA materials, which also may be applied to welds and overlay in the presence of CO<sub>2</sub> and H<sub>2</sub>S.
- To define reliable acceptance criteria for pitting corrosion in autoclave testing of CRA materials in realistic oil & gas production environments.



# Schematic of Test Layout

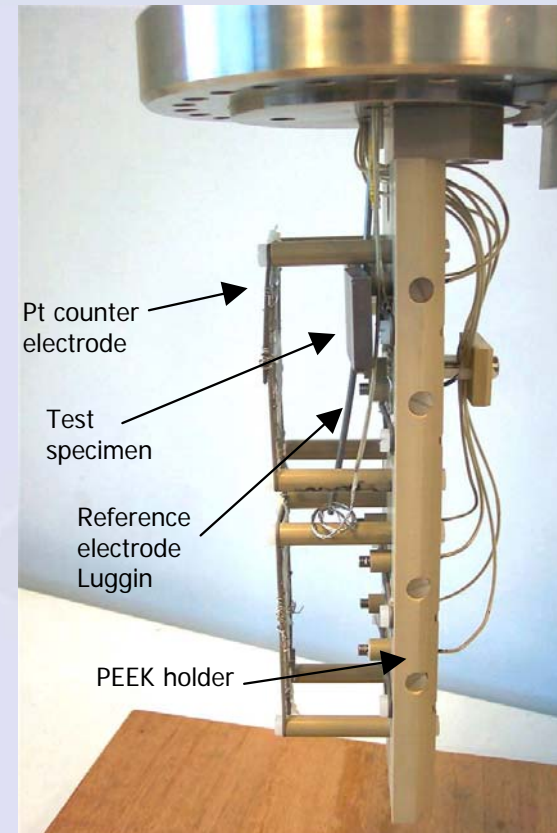
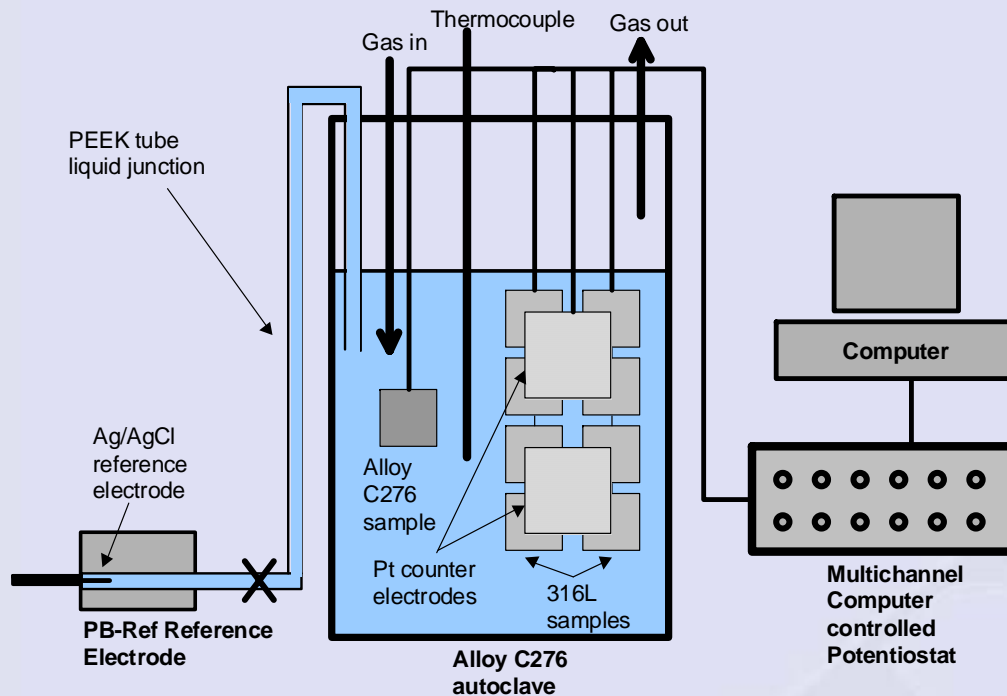



## *2-electrode arrangement used for determining CPT*

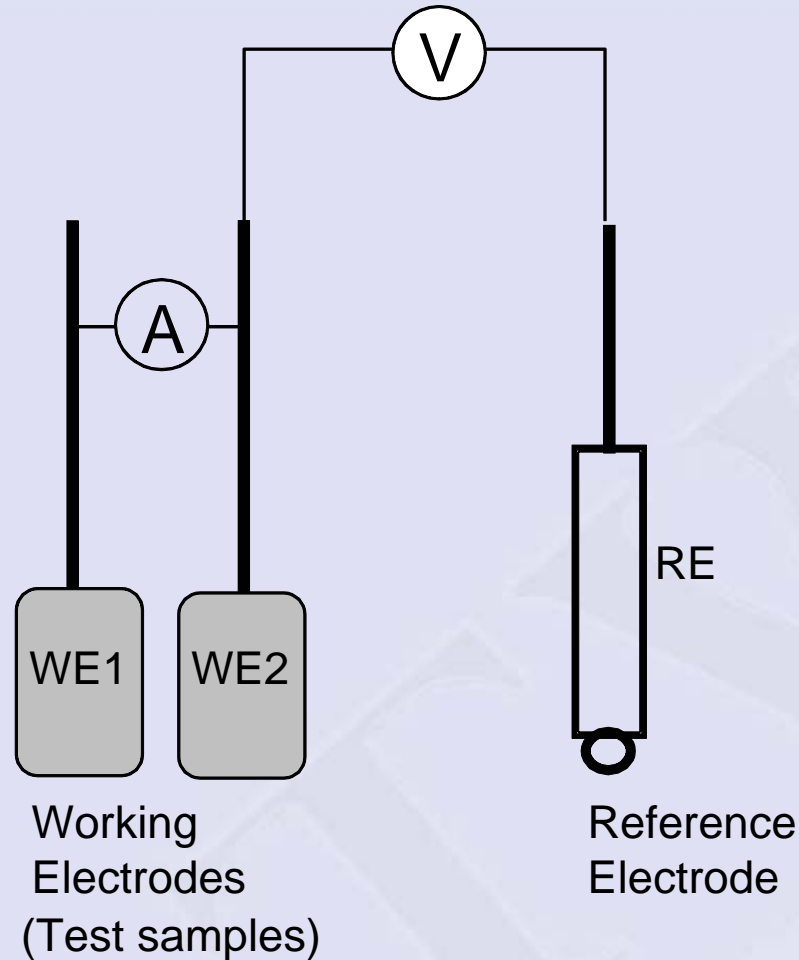

# Determination CPT in autoclave for 316L

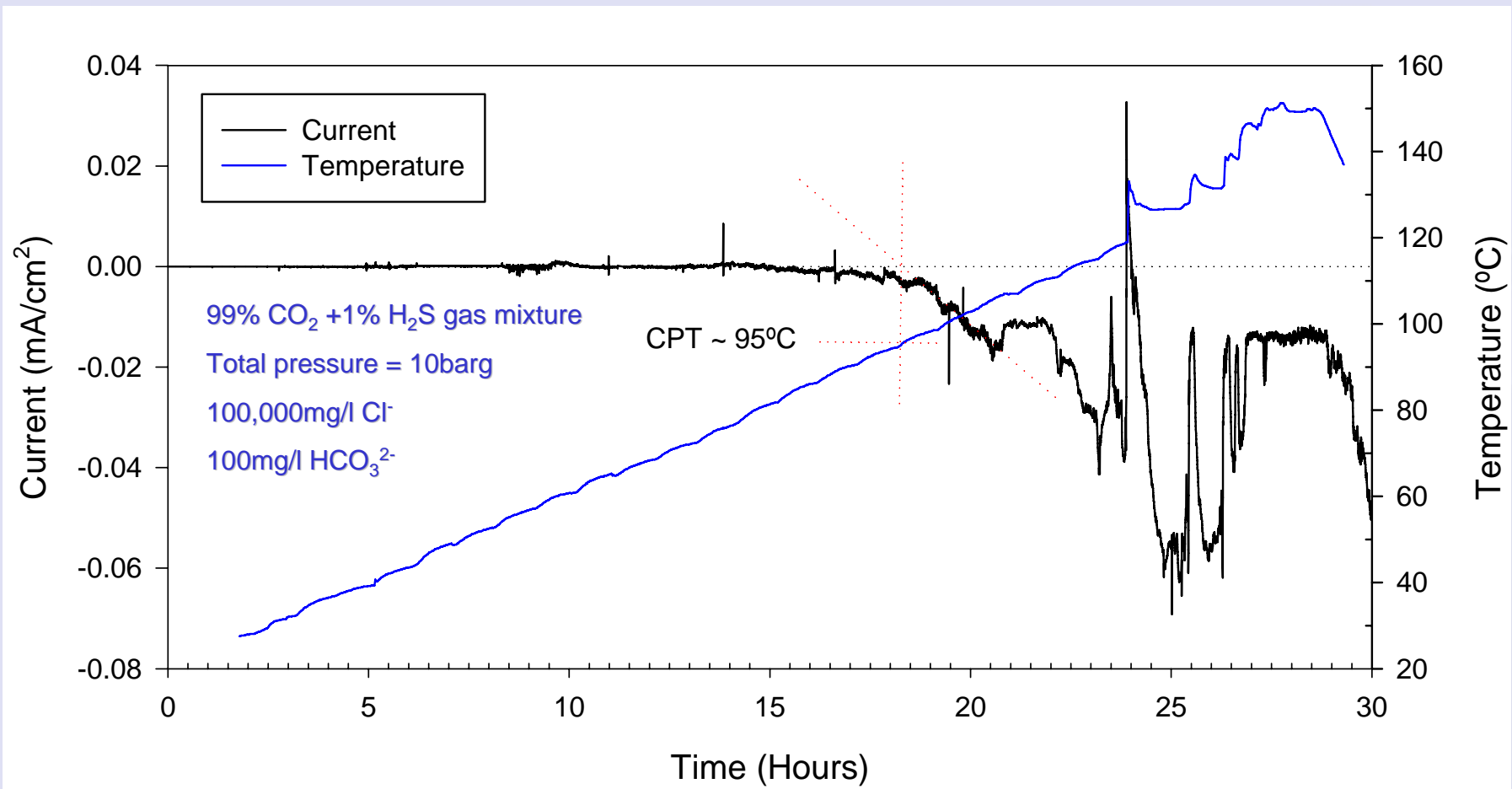

# *Conclusions*

- The work has shown that the detection of the onset of stable pitting is feasible, using current monitoring at elevated pressure and temperature, in brines containing CO<sub>2</sub> and H<sub>2</sub>S, to obtain a critical pitting temperature (CPT).
- Measured current greater than  $\pm 5\mu\text{A}/\text{cm}^2$  is proposed as the criterion for the onset of stable pitting in tests without external polarisation and with temperature ramping at a rate of 5°C/hour.
- Information presented with permission of the Sponsors: BP, ENI and UK Health & Safety Executive

# *Further Work*

- Extend work to:
  - Range of environments
  - Different materials (13%Cr, 825, 22%Cr....)
  - Welds / weld overlays
- Combine pitting monitoring with:
  - SCC/SSC 4-Point bend tests
  - Corrosion fatigue tests

## **APPENDIX 7**

## Effect of sigma phase i duplex SS on corrosion properties?

Stein Olsen

StatoilHydro



## Sigma phase in duplex SS

- Inadequate heat treatment of SS duplex fittings from one major manufacturer
  - Poor temperature control and charging procedure, not reaching the intended solution annealing temperature prior to quenching
- One major manufacturer delivering to the whole industry
  - Ongoing since 2006
  - Unknown number of fittings
  - Unknown amount of sigma phase

## Sigma phase in duplex SS

- The fittings have developed intermetallic phases (sigma, chi, Laves)
  - Can be detrimental to both the mechanical properties (toughness and ductility) and the corrosion resistance of stainless steels
- The only reliable inspection method was field microscopy
  - Inspected 2000 fittings in the field
  - 22% of the fittings contain sigma phase
- One project in the construction phase has replaced 7400 fittings



## Micrographs of sigma phase

2%



5%

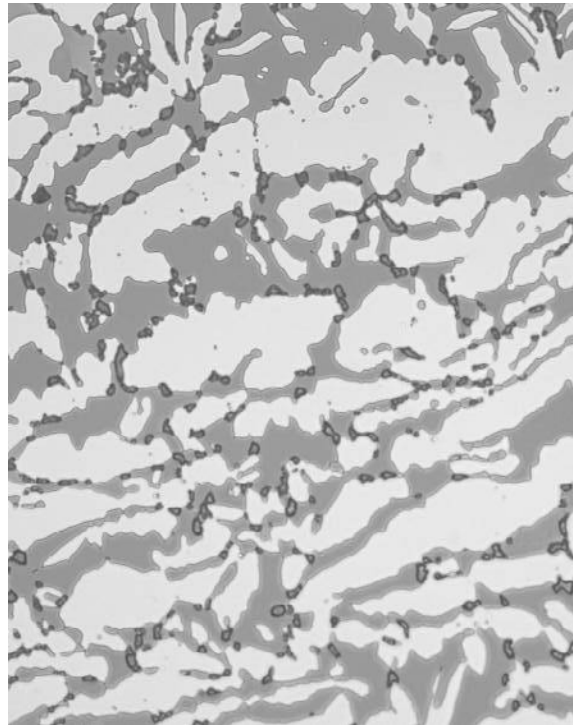

10%

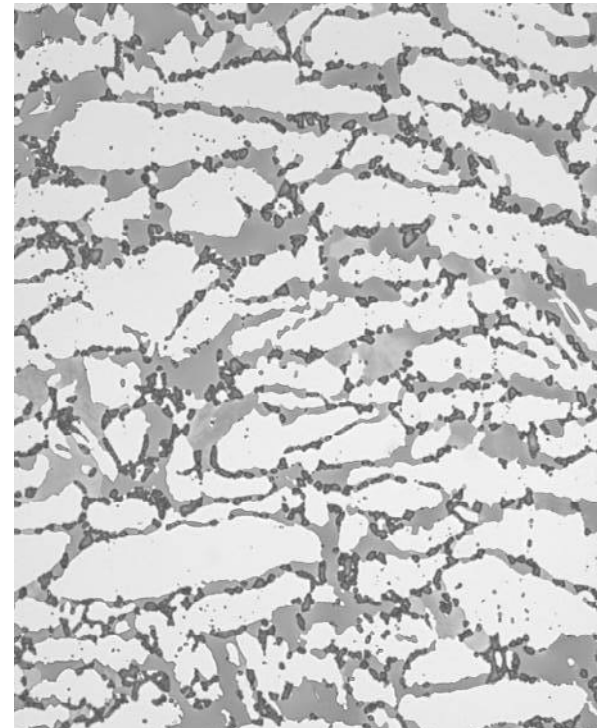

# Effect of sigma phase on toughness

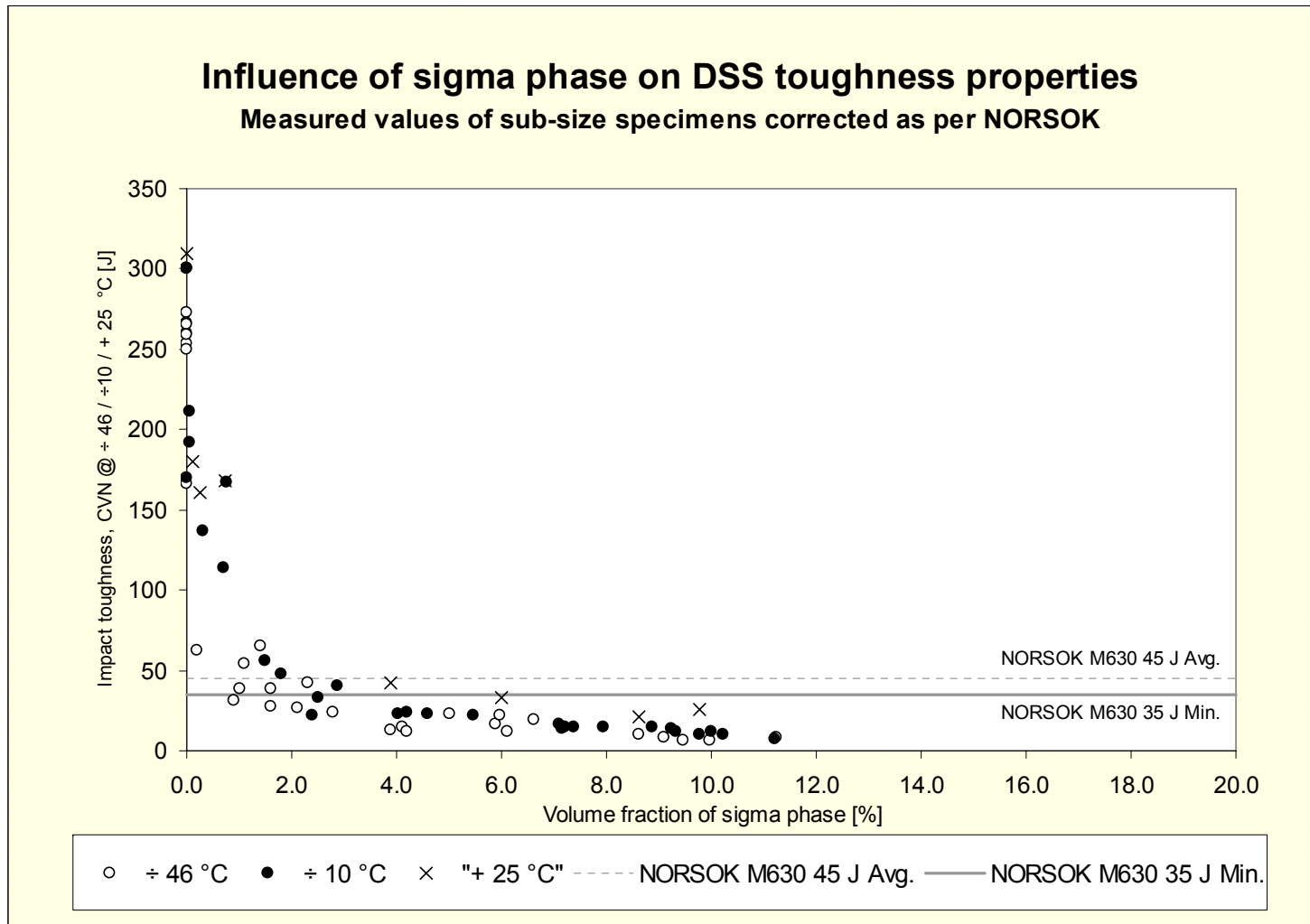

## Effect of sigma phase on corrosion properties

- Cr and Mo depletion in regions surrounding the secondary phases
- More pronounced in the austenite phase due to slower diffusion, preferential attacks typically found adjacent to the  $\gamma/\sigma$  boundary
- Secondary austenite formed in association with precipitation of secondary phases contains lower amounts of Cr, Mo and N than primary austenite
- The temperature at which they precipitate is equally important as the volume fraction of sigma phase!
  - Very difficult to obtain generic data on effect of sigma phase
  - Some data from published literature not very relevant for our application!

## Effect of $\sigma$ in 25% Cr on corrosion properties

- Mainly in seawater systems
- Risk for  $\sigma$  richment in HAZ
- ASTM G48 pitting test
  - Max 4 g/m<sup>2</sup> @50°C

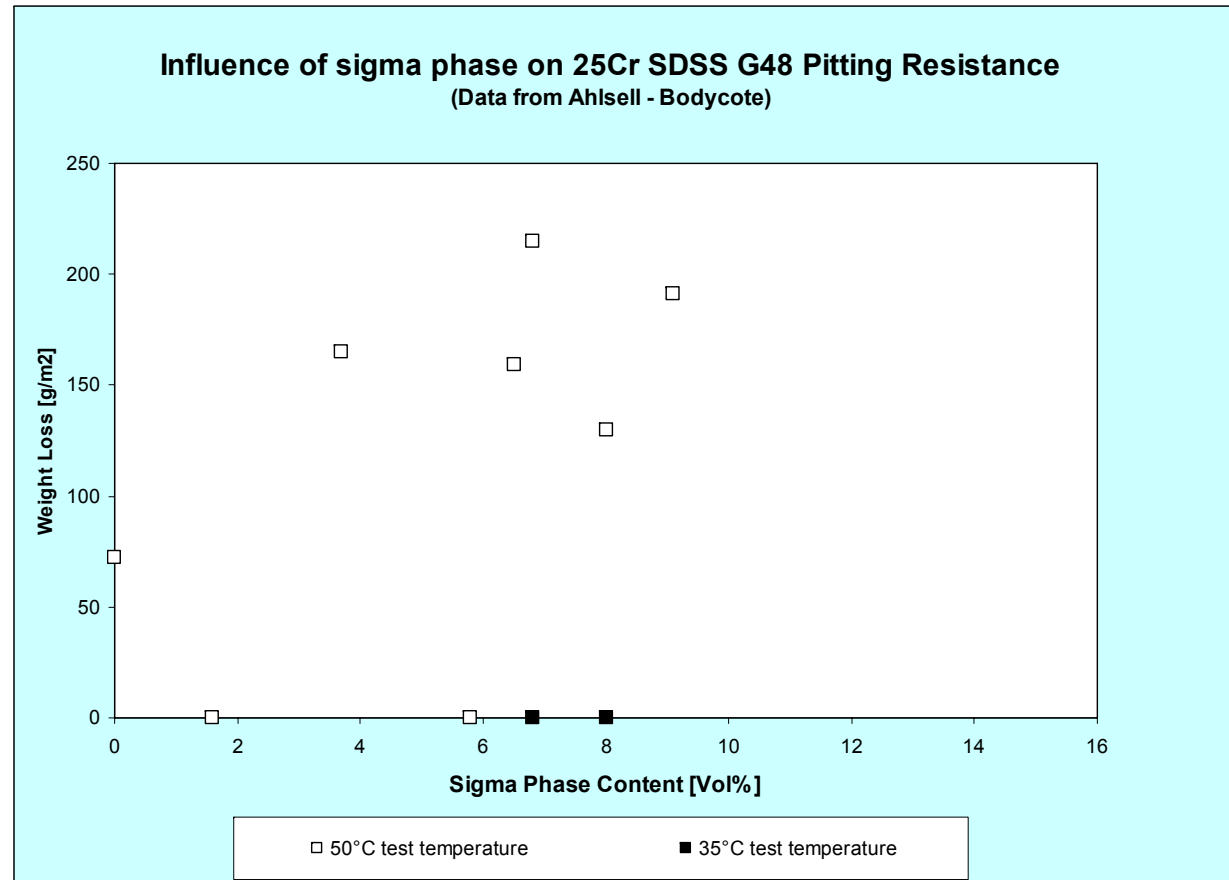

## Effect of $\sigma$ in 22% Cr on corrosion properties

Primarily used in HC systems subsea and topside

- External SCC due to salt accumulation
  - Is the critical temperature limit reduced? 100°C → 60°C?
- External Hydrogen Induced Stress Cracking from Cathodic Protection
  - Today controlled by limitations on stress and strain (DNV RP F-112)
  - Interaction between  $\sigma$  and H?
- H<sub>2</sub>S cracking
  - ISO 15156-3: 100 mbar H<sub>2</sub>S for T < 232°C for any pH and Cl<sup>-</sup>
  - How to test? (FPB/CL, T, pH<sub>2</sub>S, welds?)

## **APPENDIX 8**

**On the Beneficial Influence of a  
Very Low Supply of H<sub>2</sub>S on the  
Hydrogen Embrittlement  
Resistance of Carbon Steel  
Wires in Flexible Pipe Annulus**

**C. Taravel-Condât – N Désamais**  
Eurocorr – NICE 2009 – WP13



**Technip**



# Contents

- I. **Introduction**
- II. **Annulus composition calculations & flow rates**
- III. **Testing & results**
- IV. **Application and Example**
- V. **Conclusions**





# I. Introduction

# Flexible Pipe Applications

## ► Main applications :

- Crude oil production
- Gas production
- Water injection
- Gas injection
- Export pipeline (dead oil, gas)
- Gas lift
- Service line (chemicals...)

## ► Static flowlines or Dynamic risers

## ► From 2" to 20" ID

## ► Risers for UDW → 2500 m WD

- Need of very high strength CS armours to sustain tension loads
- But H<sub>2</sub>S

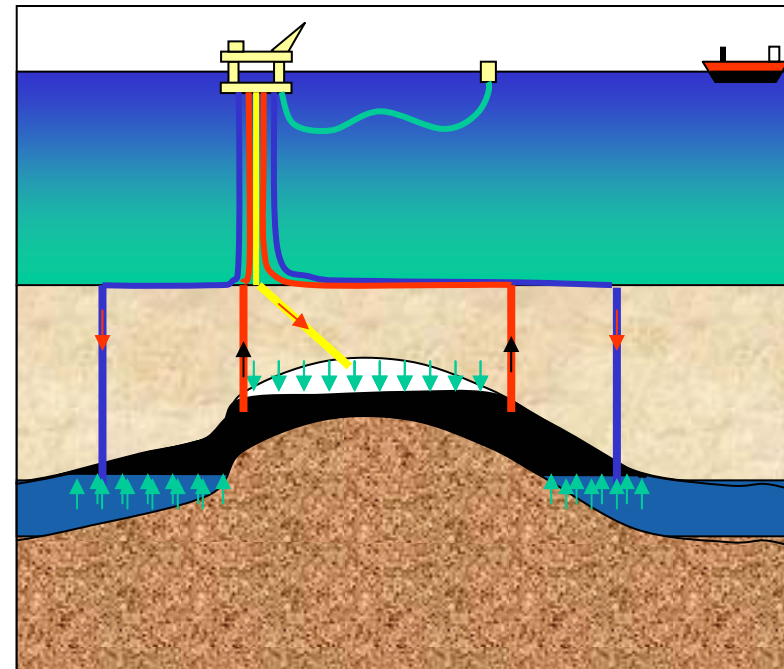

- Production line
- Water injection line
- Gas injection line
- Export line

# Flexible Pipe construction

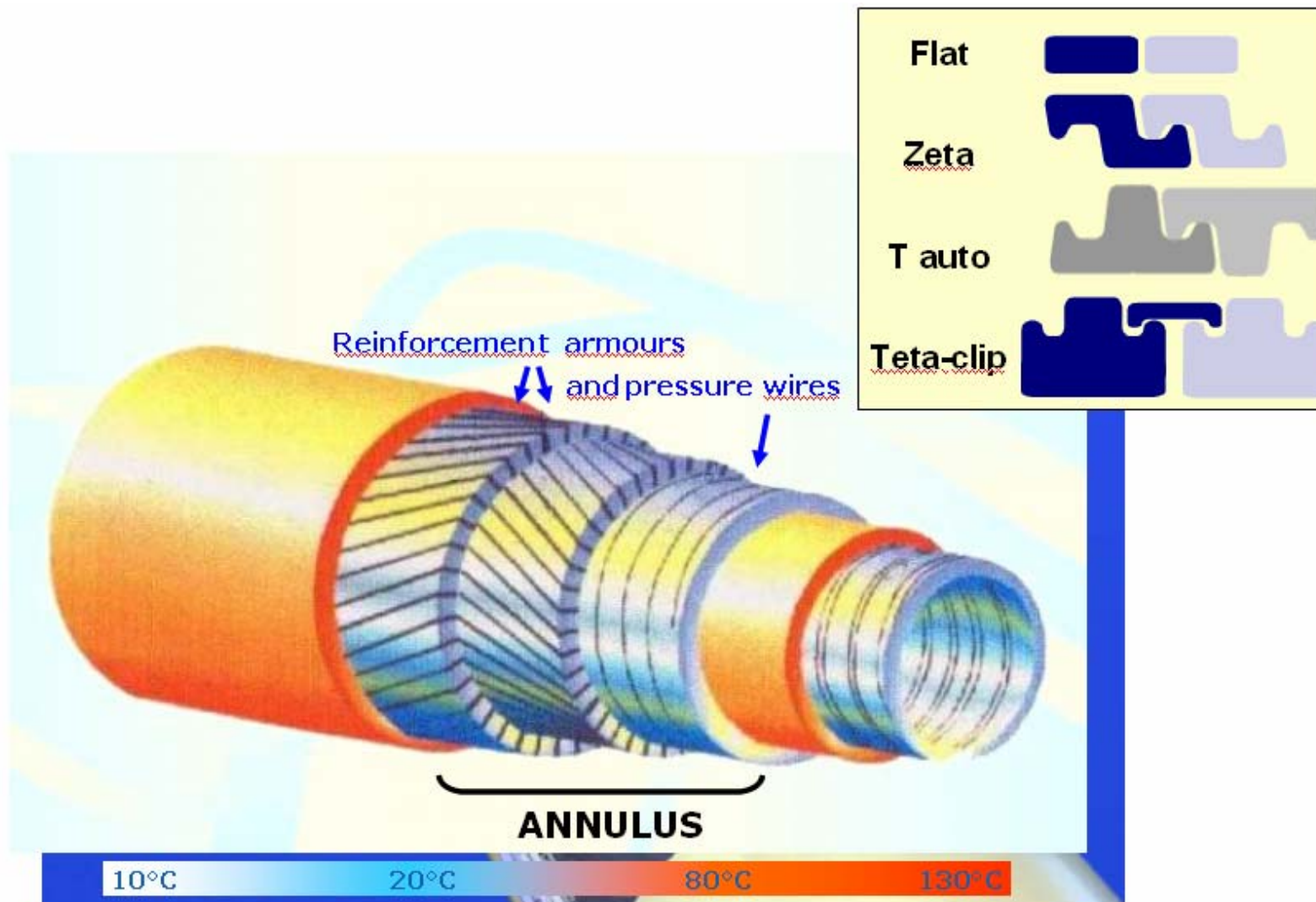



## II. Annulus composition calculations & flow rates



## Annulus specificities

- ▶ **CS wires not in direct contact with the internal fluid**
- ▶ **70% to 80% of steel**
- ▶ **10% to 20% of polymers**
- ▶ **Only 10 to 20% of free space for the environment**
- ▶ **High confinement**
  - $V/S = 0.01$  to  $0.06 \text{ ml/cm}^2$  of steel
  - Stagnant environment
  - Oxygen free ( $\text{O}_2$  quickly consumed)

**Very specific environment**

# Diffusion from the bore to the annulus

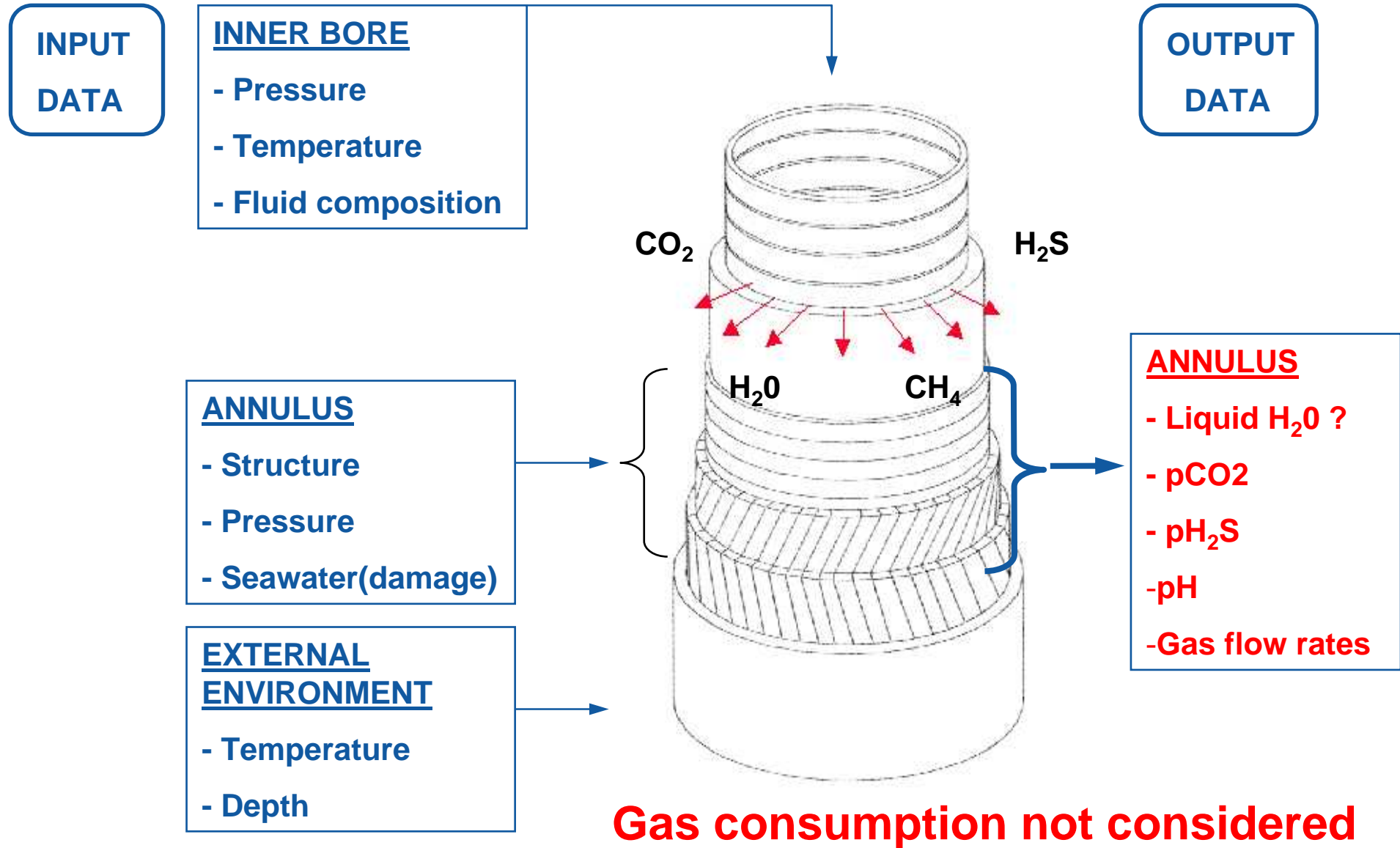

## H<sub>2</sub>S content of typical projects

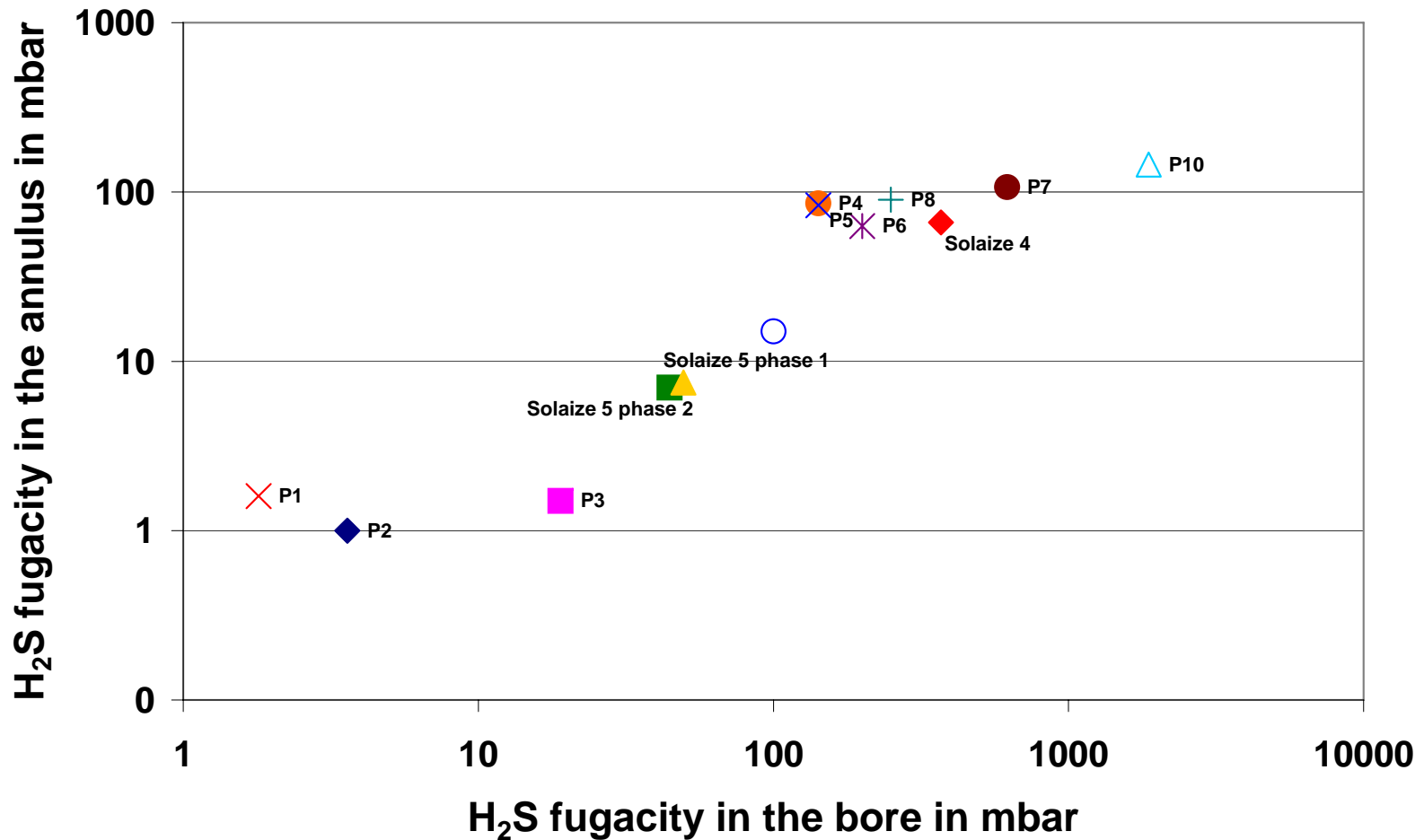

In the annulus: H<sub>2</sub>S is between 0 and 150 mbar (most severe project)

## H<sub>2</sub>S flow rates of typical project

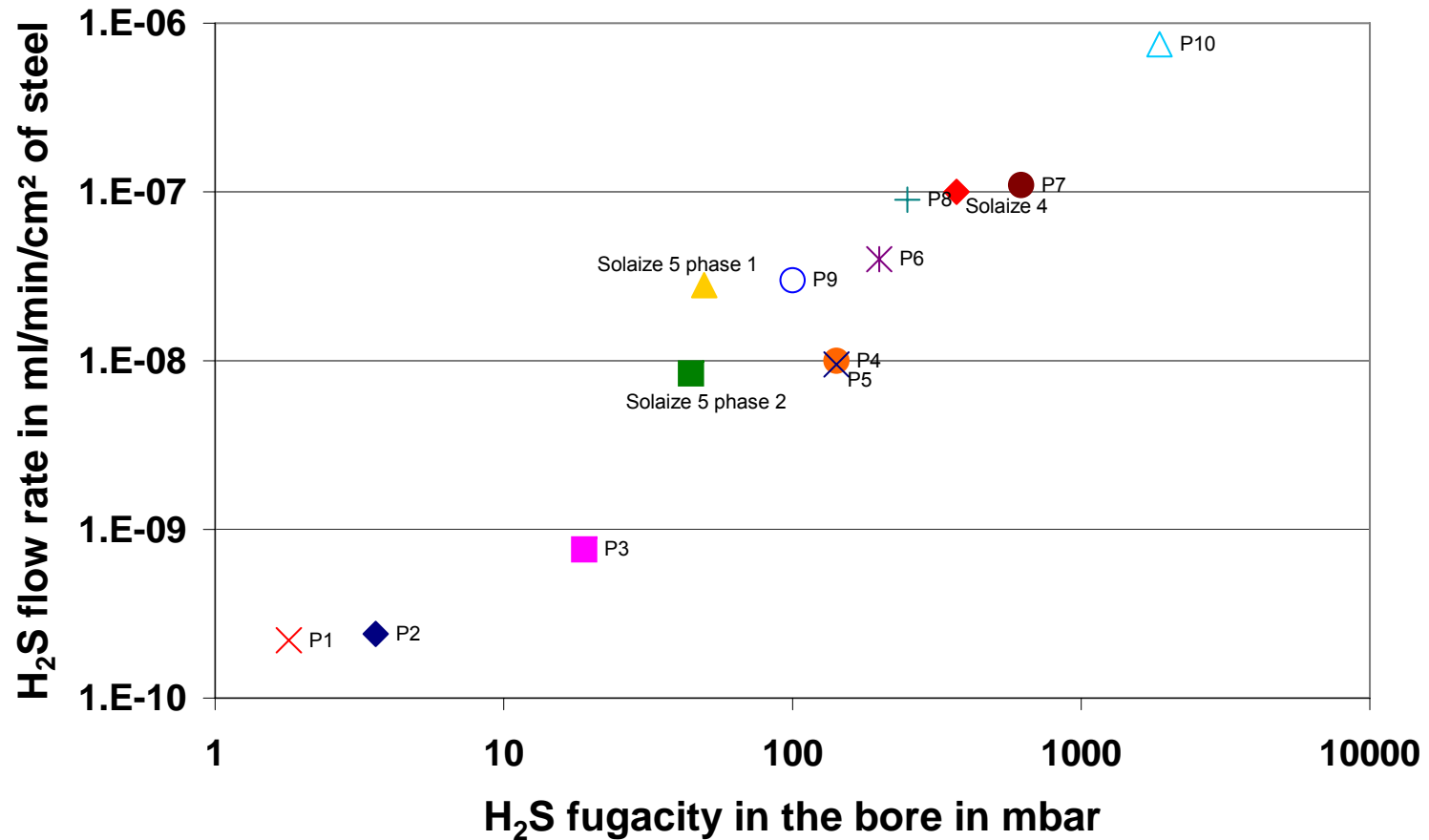

In standard SSC/HIC tests (Nace TM0177 and TM0284) :

~10<sup>-4</sup> to 10<sup>-2</sup> ml of H<sub>2</sub>S/min/cm<sup>2</sup> of steel

In the most severe project: 10<sup>-6</sup> ml of H<sub>2</sub>S/min/cm<sup>2</sup> of steel





# III. Testing and results

## Testing methodology

### ▶ Hydrogen Induced Cracking tests:

- Confined environment:  $V/S=1\text{ml/cm}^2$
- Controlled  $\text{H}_2\text{S}$  flow rate /  $\text{cm}^2$  of steel
- Gas: 0.5%  $\text{H}_2\text{S}$ / 99.5%  $\text{CO}_2$
- pH free to vary and monitored
- Ambient temperature and pressure

### ▶ Very accurate measurements of $\text{H}_2\text{S}$ species in solution

### ▶ Materials:

- sweet service Grade A:  $\text{SMUTS}=1400\text{MPa}$
- low sour service Grade B:  $\text{SMUTS}=1200\text{MPa}$

# H<sub>2</sub>S and pH Results

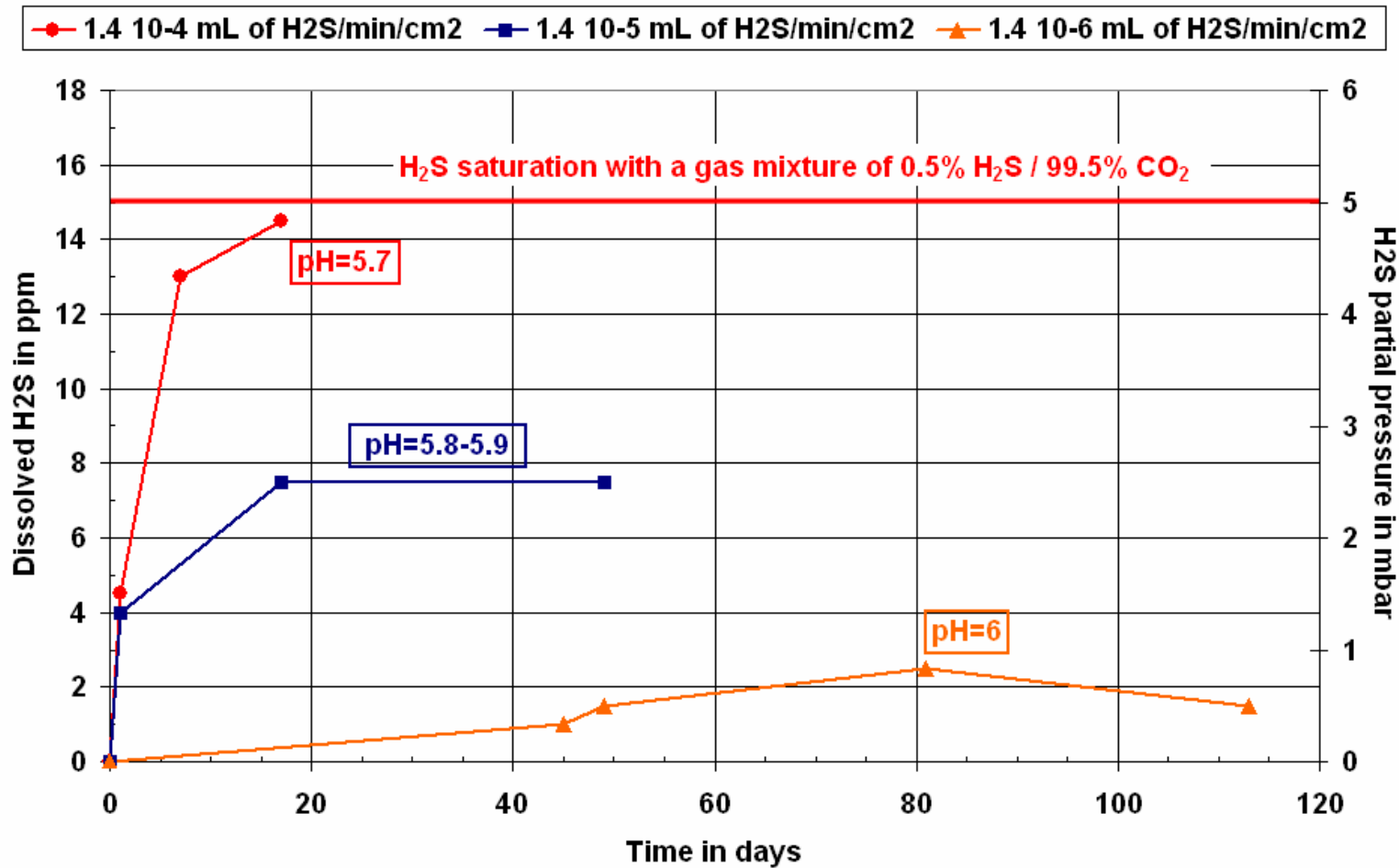

Depending on H<sub>2</sub>S flow rate:

Saturation or intermediate equilibrium (H<sub>2</sub>S consumption)

# HIC Results : ultrasonic map

Grade A  
sweet

Grade B  
low sour

$1.4 \times 10^{-4}$   
ml H<sub>2</sub>S/min/cm<sup>2</sup>

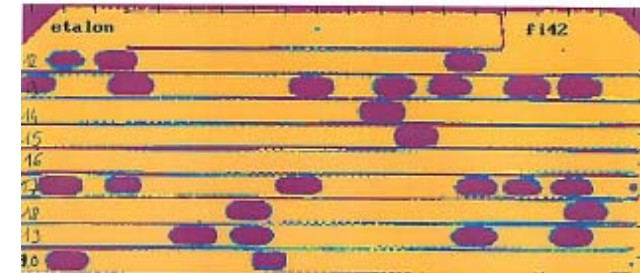
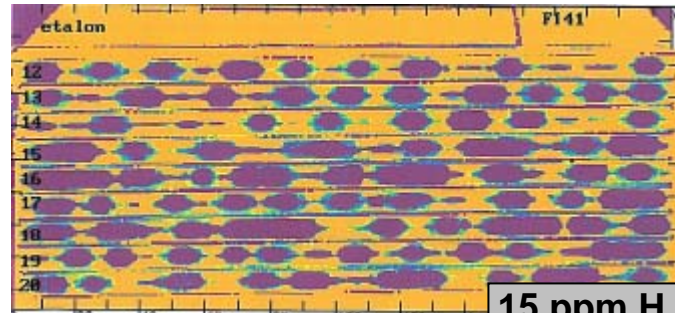

15 ppm H<sub>2</sub>S ⇔ 5 mbar H<sub>2</sub>S

$1.4 \times 10^{-5}$   
ml H<sub>2</sub>S/min/cm<sup>2</sup>

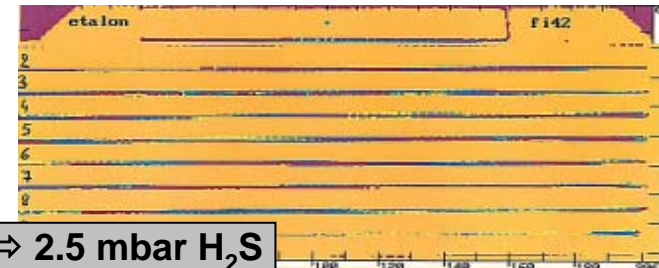
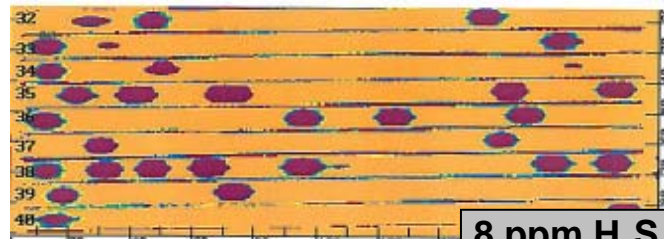

8 ppm H<sub>2</sub>S ⇔ 2.5 mbar H<sub>2</sub>S

$1.4 \times 10^{-6}$   
ml H<sub>2</sub>S/min/cm<sup>2</sup>

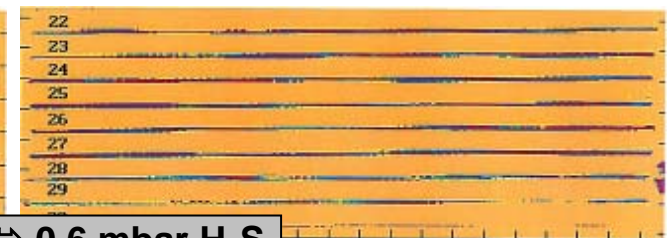
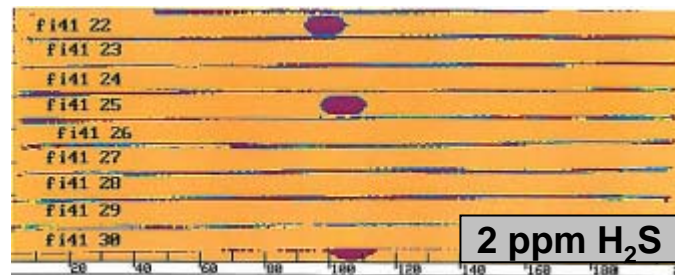

2 ppm H<sub>2</sub>S ⇔ 0.6 mbar H<sub>2</sub>S

# H<sub>2</sub>S and pH Results

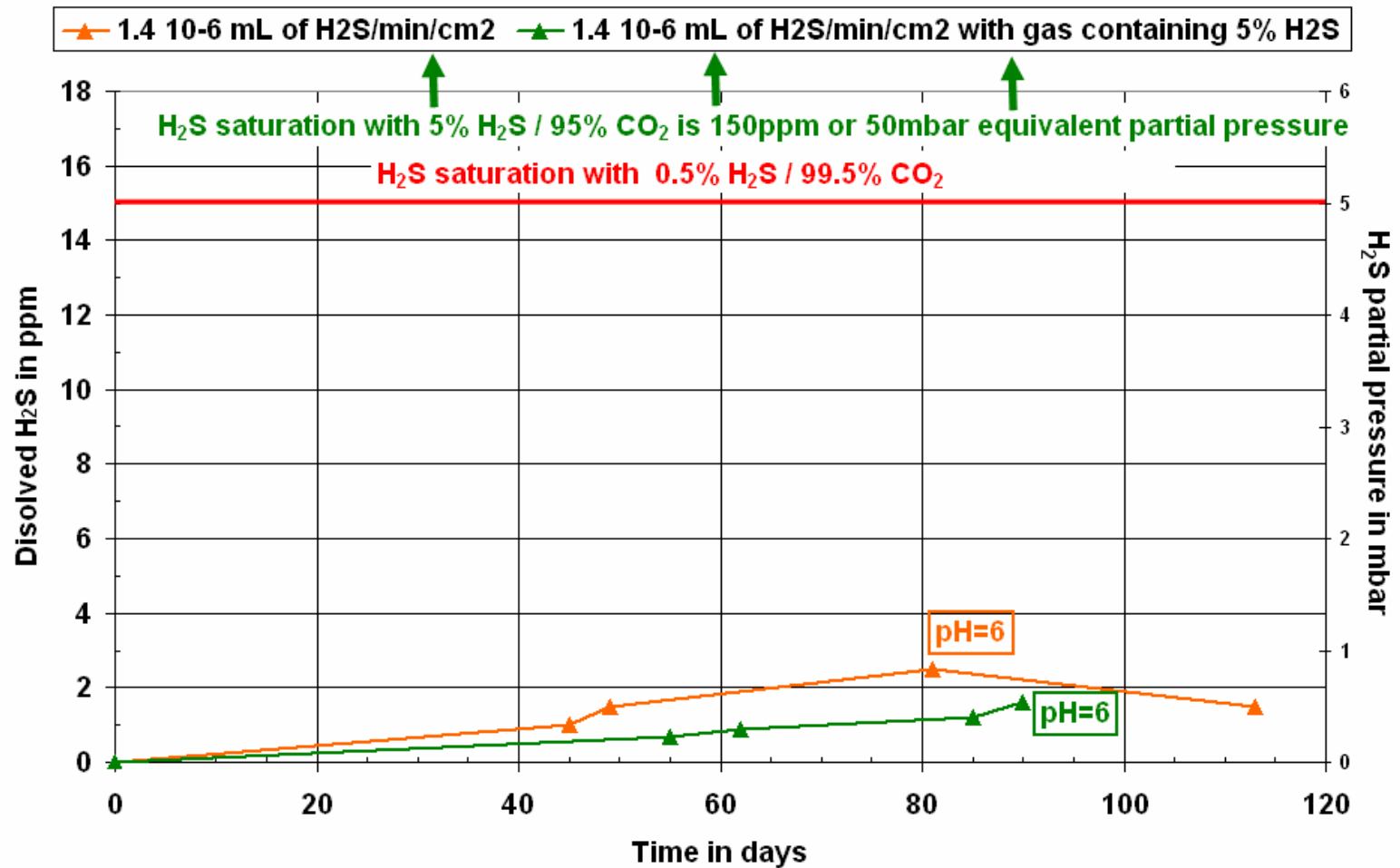

same H<sub>2</sub>S flow rate → same equilibrium

# HIC Results

Grade A  
sweet

Grade B  
low sour

$1.4 \times 10^{-6}$  ml H<sub>2</sub>S/min/cm<sup>2</sup>  
with gas 5% H<sub>2</sub>S

=

$1.4 \times 10^{-6}$  ml H<sub>2</sub>S/min/cm<sup>2</sup>  
with gas 0.5% H<sub>2</sub>S

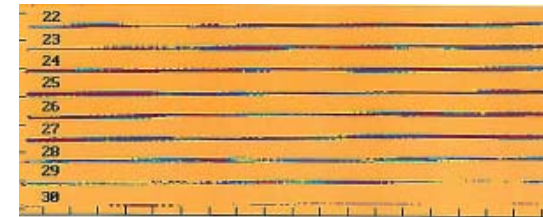
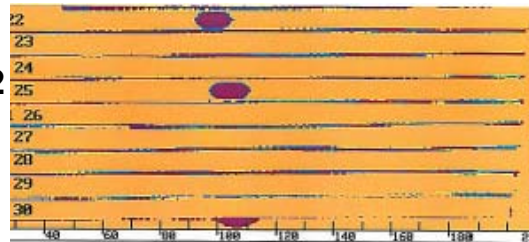
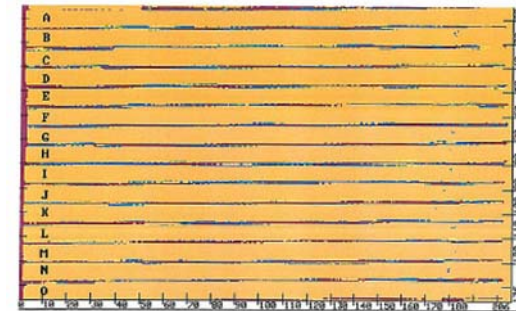
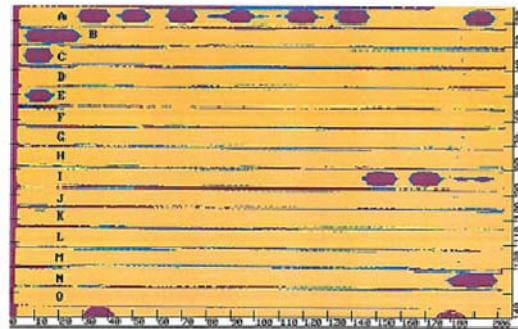

Governing parameter is: **the H<sub>2</sub>S flow rate / cm<sup>2</sup> of steel**



# IV. Application and Example

# Application to projects

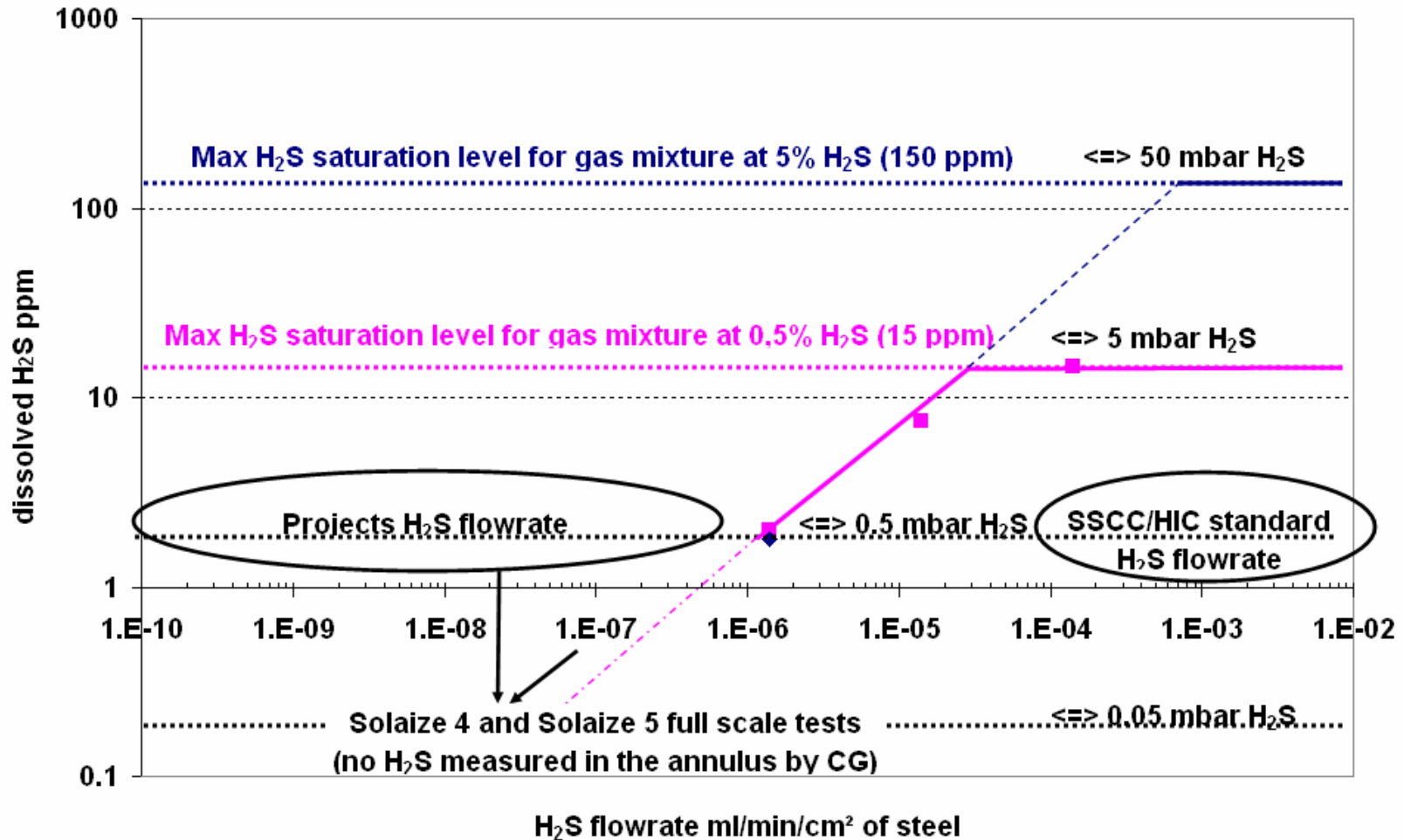



## Example

- ▶ **8 '' production riser for 1500m water depth**
- ▶ **Design pressure = 350bar – Operating Pressure=190bar**
- ▶ **Design T°C = 100°C - Operating T°C = 90°C**
- ▶ **250 ppm H<sub>2</sub>S in the bore**
- ▶ **Standard permeation calculations :**
  - **4 mbar H<sub>2</sub>S in the annulus**
  - **H<sub>2</sub>S flow rate = 10<sup>-10</sup> ml H<sub>2</sub>S/min/cm<sup>2</sup> of steel**

## Example

### ► Standard approach : sour design

- 4 armour layers with sour grade  
SMUTS=850MPa

### ► With flow rate approach:

- Flow rate=  $10^{-10}$  ml H<sub>2</sub>S/min/cm<sup>2</sup>

→ << 1mbar H<sub>2</sub>S

- 2 armour layers with low sour grade B  
SMUTS=1200MPa
- Even sweet grade A (SMUTS=1400MPa)  
could eventually be proposed

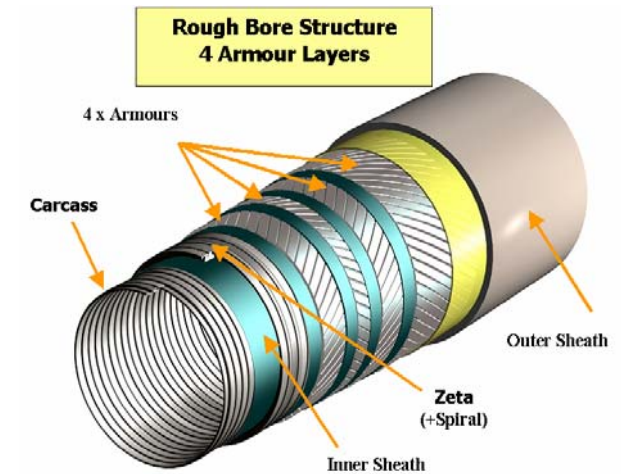

## Example

- ▶ **Weight savings**
- ▶ **Cost savings**
- ▶ **Reduces installation risks**

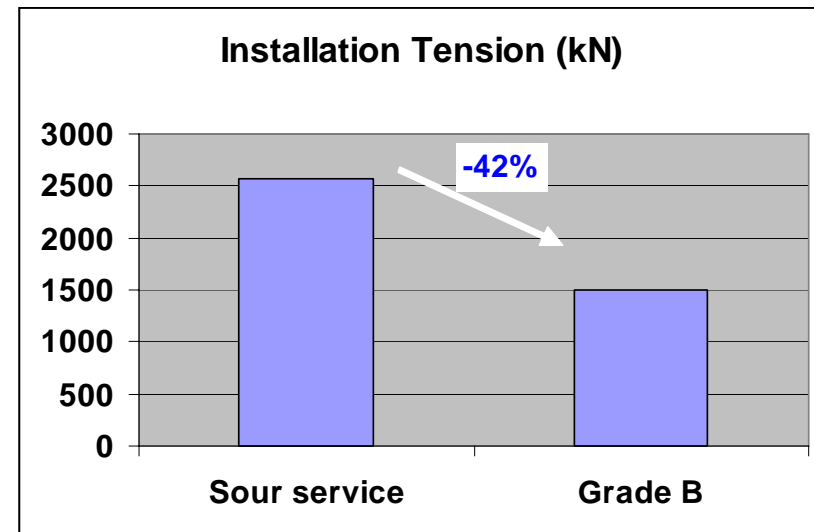
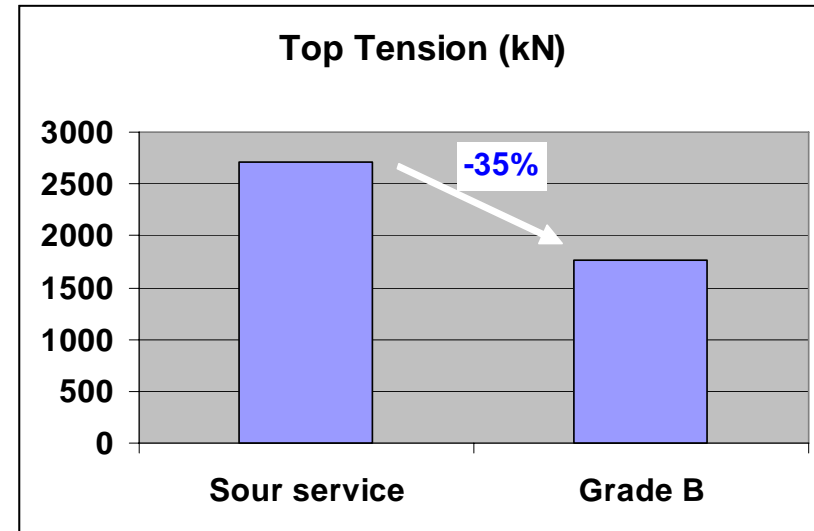



# V. Conclusions



## Conclusions

- ▶ **In flexible pipe: low H<sub>2</sub>S flow rates /cm<sup>2</sup> steel**
- ▶ **Annulus flooded → H<sub>2</sub>S consumption not negligible**
- ▶ **When H<sub>2</sub>S flow rates ↓ → environment severity ↓**  
**→ HIC damage ↓**
- ▶ **Potential impact for flexible pipe in sour ultra deep water applications**
- ▶ **Study still ongoing to confirm a safe applicability on projects**



**THANK YOU FOR YOUR  
ATTENTION**