

Minutes of EFC WP 15 Corrosion in the Refinery Industry

Graz (Austria)

9 September 2015

Prepared by

Francois Ropital

Johan van Roij

1	WELCOME	3
2	EFC WP 15 ACTIVITIES	3
2.1	EFC WP 15 activities And Minutes of Meetings	3
2.2	Vice Chairmanship of the Working Party	3
2.3	Publications from WP15	3
2.4	Downloading Previous Eurocorr Conference Papers	4
2.5	EUROCORR 2015	4
2.6	EUROCORR 2016	4
2.7	EUROCORR 2017	4
2.8	Next 2016 WP15 spring meeting	4
3	MONITORING – NAPHTHENIC ACID CORROSION	4
4	HIGH TEMPERATURE HYDROGEN ATTACK	5
5	CORROSION IN SOUR GAS AMINE UNITS TREATMENT	5
6	OTHER TOPICS OF DISCUSSION DURING THE MEETING	5
7	NEXT MEETINGS	5

1 WELCOME

Francois Ropital opened the meeting.

22 persons attended the meeting and briefly introduced themselves. The list of participants is enclosed in Appendix 1.

2 EFC WP 15 ACTIVITIES

2.1 EFC WP 15 activities And Minutes of Meetings

Information on the activities of EFC WP 15, Corrosion in the Refinery Industry, was presented by Francois Ropital. This information can also be found on the EFC web site where the minutes of previous WP15 meetings can be consulted and downloaded. More information is enclosed in Appendix 2.

<http://www.efcweb.org/Working+Parties-p-104085/WP+15-p-104111.html>

2.2 Vice Chairmanship of the Working Party

Due to his move to Saudi Arabia, Hennie de Bruyn can not regularly attend WP15 meetings and resign of his vice chairman position. Johan van Roij was appointed by the WP as the new vice chairman. All the WP members thank Hennie for his contributions to the WP activities and Johan for taking over the position.

2.3 Publications from WP15

Discussion on proposals for revision of these publications:

- EFC Guideline n°55: "Corrosion under insulation (CUI) guidelines".

The new addition of this guideline was sent to the publisher in April and will be available by the 1st November. The WP thanks Stefan and all the contributors for this great work.

http://store.elsevier.com/product.jsp?isbn=9780081007143&utm_campaign=ELS_S_TBK_20150195_BRelJuly2&utm_campaignPK=113501142&utm_term=C_20150195_088&utm_content=113501154&utm_source=93&BID=323194387&utm_medium=email&SIS_ID=0

Discussion on proposals for future publications:

- Revision of the EFC Guideline 46 "Amine units corrosion in refineries". This revision will take place in the frame of a joint WP13-15 task force and is presented in more details in paragraph 5 of these minutes.
- A best practice guideline to avoid and characterize high temperature stress relaxation cracking of austenitic materials.

2.4 Downloading Previous Eurocorr Conference Papers

Papers from the previous Eurocorr conferences (from Eurocorr 2004 to 2014) can be downloaded via the member's pages of each of the national member societies of EFC. The list of EFC member societies is available on the web page:

<http://www.efcweb.org/Who+we+are/Member+Societies.html>

Please contact your member society for more information on access to these papers.

2.5 EUROCORR 2015

This annual working party meeting was held in Graz during the Eurocorr 2015 conference "Earth, Fire, Water, Corrosion happens everywhere".

The session dealing with refinery corrosion has been held on 9th September. Attendance of this sessions was between 25 and 45 persons, figures that reflects the attendance of the 2015 conference with nearly 830 participants.

2.6 EUROCORR 2016

Eurocorr 2016 "Advances in linking science and engineering" will take place in Montpellier, France from 11-15 September 2016.

<http://www.eurocorr.org/eurocorr2016.html>

In addition to the corrosion refinery session, a joint session co-organized with WP 19 (Corrosion of polymer materials) on the behaviour of plastic materials in refineries petrochemical and chemical plants will take place.

Abstracts for these sessions are welcomed and the deadline for submission is **17 January 2016**.

2.7 EUROCORR 2017

Eurocorr 2017 "Corrosion control for safer living" will take place in Prague, Czech Republic from 3-7 September 2017. This conference will be associated with the 20th International Corrosion Congress (ICC).

<http://prague-corrosion-2017.com/>

2.8 Next 2016 WP15 spring meeting

The participants agreed to continue to have 2 working party meetings per year: one in spring and one during the annual Eurocorr conference.

Patrice Houlle (MTI European associate director) proposed to organize the 2016 WP15 spring meeting in connection with a MTI workshop on High Temperature Hydrogen Attack. This event could take place in Paris: 12th April WP15 spring meeting, 13th April Roundtable WP15-MTI on HTHA, 14-15th April MTI meeting. This information has to be confirmed.

3 MONITORING – NAPHTHENIC ACID CORROSION

John Bromley-Barratt presented Permasense technology to enhance crude slate flexibility. Case studies have also been discussed. More information can be found in Appendix 3.

4 HIGH TEMPERATURE HYDROGEN ATTACK

Due to recent HTHA of carbon steel equipment failures and the CSB report, a revised API RP 941 document (proposed 8th edition) should be available by the end of 2015.

5 CORROSION IN SOUR GAS AMINE UNITS TREATMENT

On 8th Sept 2015, in a joint EFC WP13, WP15 “Task Force meeting” took place and a proposal was launched to update the “Amine unit Corrosion in Refineries”, EFC publication 46 The motivation for updating the publication is that there may be new experience especially when experience from similar units in gas plants can be included and that there is also a need to translate the experience into something that can be used as a guideline to mitigate corrosion in amine gastreating units.

Johan van Roij volunteered to be the focal point for the task force and can be contacted with ideas, contributions, etc. (by the task force members and other interested people).

You will find more details in Appendix 4 with minutes of the taskforce meeting and the presentation of Johan van Roij.

6 OTHER TOPICS OF DISCUSSION DURING THE MEETING

The following topics have been discussed:

- Sulphidation of no defined Si content carbon steel;
- Enrichment with new failure cases of the dedicated EFC WP15 web page.

7 NEXT MEETINGS

2016 Spring WP15 Meeting

This meeting is planned to take place on 12 April 2016 in Paris – France – **to be confirmed**

2016 Autumn Full WP 15 Meeting:

This meeting will take place in Montpellier, France, during the Eurocorr 2016 conference from 11-15 September 2016.

Appendix 1

List of participants

Participants EFC WP15 meeting 9th September 2015 Graz (Austria)

Name		Company
Billingham	Mike	WG Intetech Ltd
Brandl	Ramona	OMV
Bromley-Barratt	John	Permasense Ltd
Cicomascolo	Francesco	Böhler Welding Holding GmbH
Davies	Jack	Permasense
Feather	Jim	NACE
Fenton	Stephen	Steve Fenton Consultants
Gierlinger	Matthias	Borealis Polyolefine GmbH
Goldberg	Linda	NACE
Goti	Raphael	Total Refining & Chemicals
Holmes	Tracey	Special Metals
Houille	Patrice	Patrice Houille Corrosion Service - MTI
Kornienko	Elena	Gunvor Raffinerie Ingolstadt GmbH
Kus	Slawomir	Honeywell
Marcolin	Giacomo	Tenaris Dalmine
Ropital	François	IFP Energies nouvelles
Simm	Andrew	WG Intetech Ltd
Suleiman	Mabruk	Takreer
Van Rodijnen	Fred	Oerlikon metco
van Roij	Johan	Shell Global Solutions International B.V.
Vosecký	Martin	Nalco
Yamamoto	Katsumi	The Japan Society of Corrosion Engineering

Appendix 2

EFC WP15 Activities

(Francois Ropital)



Presentation of the activities of WP15

European Federation of Corrosion (EFC)

- Federation of 31 National Associations
- 21 Working Parties (WP) and 1 Task Force
- Annual Corrosion congress « Eurocorr »
- Thematic workshops and symposiums
- Working Party meetings (for WP15 twice a year)
- Publications
- EFC - NACE agreement (20% discount on books price)
- for more information <http://www.efcweb.org>

EFC WP15 Annual meeting 9 September 2015 Graz - Austria

1



EFC Working Party 15 « Corrosion in Refinery » Activities

Who is an EFC member

To be an EFC member you (individually or your company, university) has to be member of one of 31 national EFC "member societies". Your company or university can now also an affiliate member.

For example:

in Norway: Norsk Korrojonstekniske Forening

in France: Cefracor or Federation Française de Chimie

in Germany: Dechema or GfKORR

in UK: Institute of Corrosion or IOM or NACE Europe

in Israel: CAMPI or Israel Corrosion Forum

in Poland: Polish Corrosion Society

.....

You will find all these information on www.efcweb.org or in the EFC Newsletter

Benefits to be an EFC member:

- 20% discount on EFC Publications and NACE Publications

-reduction at the Eurocorr conference

-access the [new EFC web restricted pages](#) (papers of the previous Eurocorr Conference) via your national corrosion society web pages

EFC WP15 Annual meeting 9 September 2015 Graz - Austria

2

- WP 1: Corrosion Inhibition
- WP 3: High Temperature
- WP 4: Nuclear Corrosion
- WP 5: Environmental Sensitive Fracture
- WP 6: Surface Science and Mechanisms of corrosion and protection
- WP 7: Education
- WP 8: Testing
- WP 9: Marine Corrosion
- WP 10: Microbial Corrosion
- WP 11: Corrosion of reinforcement in concrete
- WP 12: Computer based information systems
- WP 13: Corrosion in oil and gas production
- WP 14: Coatings
- WP 15: Corrosion in the refinery industry
(created in sept. 96 with John Harston as first chairman)
- WP 16: Cathodic protection
- WP 17: Automotive
- WP 18: Tribocorrosion
- WP 19: Corrosion of polymer materials
- WP 20: Corrosion by drinking waters
- WP 21: Corrosion of archaeological and historical artefacts
- WP 22: Corrosion control in aerospace
- Task Force on Corrosion in CO₂ Capture Storage (CCS) applications

Chairman: Francois Ropital

Deputy Chairman: to be nominated

The following are the main areas being pursued by the Working Party:

Information Exchange

Sharing of refinery materials /corrosion experiences by operating company representatives.

Forum for Technology

Sharing materials/ corrosion/ protection/ monitoring information by providers

Eurocorr Conferences

WP Meetings

One WP 15 working party meeting in Spring,
One meeting at Eurocorr in September in conjunction with the conference,

Publications - Guidelines

List of the WP15 spring meetings :

10 April 2003	Pernis - NL (Shell)
8-9 March 2004	Milan -Italy (ENI)
17-18 March 2005	Trondheim- Norway (Statoil)
31 March 2006	Porto Maghera - Italy (ENI)
26 April 2007	Paris - France (Total)
15 April 2008	Leiden -NL (Nalco)
23 April 2009	Vienna - Austria (Borealis)
22 June 2010	Budapest - Hungary (MOL)
14 April 2011	Paris - France (EFC Head offices)
26 April 2012	Amsterdam - NL (Shell)
9 April 2013	Paris - France (Total)
8 April 2014	Mechelen - Belgium (Borealis)
14 April 2015	Leiden -NL (Nalco)

Publications from WP15

- **EFC Guideline n°40 « Prevention of corrosion by cooling waters »** available from <http://www.woodheadpublishing.com/en/book.aspx?bookID=1193>

Update in relation with Nace document 11106 "Monitoring and adjustment of cooling water treatment operating parameters" Task Group 152 on cooling water systems

- **EFC Guideline n° 46 on corrosion in amine units**
<http://www.woodheadpublishing.com/en/book.aspx?bookID=1299>

- **EFC Guideline n° 42 Collection of selected papers**
<http://www.woodheadpublishing.com/en/book.aspx?bookID=1295>

- **EFC Guideline n° 55 Corrosion Under Insulation**
<http://www.woodheadpublishing.com/en/book.aspx?bookID=1486>



- Future publications : suggestions ?
 - best practice guideline to avoid and characterize stress relaxation cracking ?

. Collaboration with Nace : exchange of minutes of meetings TEG 205X,, ...

. Sessions with other EFC WP at Eurocorr (2016-Montpellier-France, 2017 Prague-Czech Republic, 2018 Krakow-Poland) on which topics?

For the Eurocorr 2016 proposal of joint session on corrosion of organic materials and the refinery, petrochemical and chemical industries

- Update of publications
 - Corrosion in amine treatment units

- New Publications:
 - best practice guideline to avoid and characterize stress relaxation cracking ?
 - sour gas amine treatment units

- Education - qualification - certification
 - List of "corrosion refinery" related courses on EFC website ?
 - Proposal of courses within Eurocorr ?

EFC WP15 Annual meeting 9 September 2015 Graz - Austria

7

•6-10 March 2016
Nace Conference 2016 Vancouver Canada



•15-20 May 2016
High Temperature Corrosion and Protection of Materials - Les Embiez France
<http://www.htcpm2016.com/>



•11-15 September 2016
EUROCORR 2016 Montpellier France



Look at the Website: www.efcweb.org/Events

EFC WP15 Annual meeting 9 September 2015 Graz - Austria

8

Corrosion under insulation Point on the revision of the CUI guideline

ELSEVIER STORE

Search by Keyword, Title, Author, ISBN, ISSN

Cart (0)

Products Subjects Imprints **Special Offers** **FREE SHIPPING***

Home » Engineering » Engineering - General » Corrosion Under Insulation (CUI) Guidelines

Like us on:

Corrosion Under Insulation (CUI) Guidelines, 2nd Edition Revised

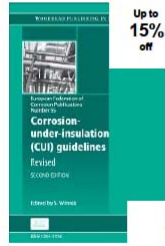

Up to
**15%
off**

Editor: S Winnik
Expected Release: 01 Nov 2015
Date:
Imprint: Woodhead Publishing
Print Book ISBN: 9780081007143
Pages: 192
Dimensions: 229 X 152

Print Book
Hardcover
Not Yet Available
Estimated Delivery Time

EUR 148,75
EUR 125,00
1

Buy Online

Provides fully updated and revised technical guidance on managing CUI, a common problem that occurs in the refining, petrochemical, power, industrial, onshore and offshore industries

Add to Wish List

WP15 Corrosion Atlas Web page

www.efcweb.org/Working+Parties/WP+Corrosion+in+the+Refinery+Industry/WP+15+Refinery+Corrosion+Atlas.html



EUROPÄISCHE FÖDERATION KORROSION
EUROPEAN FEDERATION OF CORROSION
FÉDÉRATION EUROPÉENNE DE LA KORROSION

Search

Home | Sites | Imprint | Privacy | Contact | Page

Who we are

EFC Membership

Working Parties

- WP Corrosion and Scale Inhibition
- WP Corrosion by Hot Gases and Combustion Products
- WP Nuclear Corrosion
- WP Environment Sensitive Fracture
- WP Surface Science and Mechanisms of Corrosion and Protection
- WP Corrosion Education
- WP Physico-chemical Methods of Corrosion Testing
- WP Marine Corrosion
- WP Microbial Corrosion
- WP Corrosion of Steel in Concrete
- WP Corrosion in Oil and Gas Production
- WP Coatings
- WP Corrosion in the Refinery Industry
- WP 15 Refinery Corrosion Atlas CUI Restricted Web Page
- WP Cathodic Protection
- WP Automotive Corrosion

Welcome » Working Parties » WP Corrosion in the Refinery Industry » WP 15 Refinery Corrosion Atlas

EFC Working Party 15: Corrosion in the Refinery Industry

WP 15 REFINERY CORROSION ATLAS

On this page you will find some corrosion failure cases from the refinery and process industries. These documents are only given for information and do not engage EFC.

- Failure case n°1: High temperature corrosion of a first stage reactor of a hydrocracking unit
- Failure case n°2: Chloride stress corrosion cracking of a H2S stripping tower in a hydrosulfurization unit
- Failure case n°3: Creep and cracks in a hydrosulfurization unit
- Failure case n°4: Chloride stress corrosion cracking of mounting hardware in a FCC
- Failure case n°5: Metal dusting corrosion of a furnace tube in reforming unit
- Failure case n°6: Sulfidation in an atmospheric distillation unit
- Failure case n°7: HF stress corrosion cracking in an alkylation unit
- Failure case n°8: Carbonate stress corrosion cracking in an FCC unit

If you would like to add other failure cases, you can complete the enclosed file and send it to François Rogstad email: francois.rogstad@ipera.fr

Appendix 3

Monitoring – Naphthenic acid corrosion

(John Bromley-Barratt)





Experts in remote monitoring solutions

**Monitoring for Napthenic Acid Attack to enhance
crude slate flexibility**

Jake Davies, Marketing Director, Permasense Ltd

www.permasense.com Experts in Remote Monitoring Solutions



Experts in remote monitoring solutions

Industry challenges

www.permasense.com Experts in Remote Monitoring Solutions



Industry challenges

- **Managing safety, integrity and risk management**
 - More aggressive process fluids
 - Variable feedstock quality
 - Higher plant availability requirements
 - Longer runs between maintenance shutdowns
 - Tighter HSE regulations
 - Tighter CAPEX budgets
 - More hostile working environments
 - Shortage of experienced inspectors







- Industry challenges
- Company >
- Solutions >
- System outputs >
- System benefits
- Business case
- Technology
- Deployment >
- Applications >
- Summary

www.permasense.com

3

Experts in Remote Monitoring Solutions



Industry challenges: corrosion and erosion issues

- **Well understood:**
 - Process conditions
 - Crude constituents
 - Abrasive solids
 - Inhibitors
 - Metallurgy
- **Not well understood:**
 - Rate of damage
 - Variability of rate of damage from above factors
- **Leading to:**
 - Conservative operations, and/or feedstocks
 - Unplanned outages, and/or loss of containment







- Industry challenges
- Company >
- Solutions >
- System outputs >
- System benefits
- Business case
- Technology
- Deployment >
- Applications >
- Summary

www.permasense.com

4

Experts in Remote Monitoring Solutions

Deployed worldwide, extensive references

>10,000 sensors in >90 facilities in >20 countries

- Refineries
- LNG plants
- Offshore platforms
- Onshore oil gathering systems
- Pipelines
- FPSOs
- Power plants (gas and geothermal)

permasense

- Industry challenges
- Company >
- Solutions >
- System outputs >
- System benefits
- Business case
- Technology
- Deployment >
- Applications >
- Summary

www.permasense.com Experts in Remote Monitoring Solutions

Complete system – sensors to software, data-to-desk

Short-range system – refineries, gathering facilities, petchem, power stations...

Permasense sensor

Max 100 sensors per gateway

50 metres max per 'hop', up to 8 'hops'

GATEWAY

Example location: Control room

User's office

Data viewer software

Network

Server with database

Remote access for Permasense support

2 wireless protocols available: Permasense proprietary protocol and WirelessHART, both 2.4GHz unlicensed band

permasense

- Industry challenges
- Company
- Solutions
- Short-range
- Long-range
- Modular
- System outputs >
- System benefits
- Business case
- Technology
- Deployment >
- Applications >
- Summary

www.permasense.com Experts in Remote Monitoring Solutions

Straightforward, robust data retrieval

Wireless

- inexpensive deployment
- no cable to install or be damaged

Mesh

- minimal line of sight requirements
- up to 400m / yard range from gateway (network and power access) with up to 8 hops
- multiple pathways – robust
- 25 sensors per unit is sensible density requirement
- More sensors (higher mesh density) adds robustness

Typical example of sensor to sensor communication in CDU

~ 200m

permasense

Industry challenges

Company

Solutions

Short-range

Long-range

Modular

System outputs >

System benefits

Business case

Technology

Deployment >

Applications >

Summary

www.permasense.com Experts in Remote Monitoring Solutions

Short-range system on process units

permasense

Industry challenges

Company

Solutions

Short-range

Long-range

Modular

System outputs >

System benefits

Business case

Technology

Deployment >

Applications >

Summary

www.permasense.com Experts in Remote Monitoring Solutions



permasense[®]
Experts in remote monitoring solutions

System outputs

www.permasense.com Experts in Remote Monitoring Solutions

Data delivered automatically to database, viewed and analysed at your desk



NB: Users can switch between Metric and Imperial units

www.permasense.com Experts in Remote Monitoring Solutions

Industry challenges
Company
Solutions >
System outputs
Data
Reporting
Localised corrosion
System benefits
Business case
Technology
Deployment >
Applications >
Summary

Quality and frequency of data affords fast response to corrosion or erosion

- Excellent measurement repeatability affords detection and measurement of ~10s microns (~1 mils) of metal wall loss
- This quality of data and regular data delivery (every 12 hours by default but configurable) affords detection of corrosion or erosion events within days (or quicker if loss rates are more severe)

Wall thickness, mm

0.002" 0.05mm

3 days

Time (1 month)

www.permasense.com Experts in Remote Monitoring Solutions

Industry challenges
Company
Solutions >
System outputs
Data
Reporting
Localised corrosion
System benefits
Business case
Technology
Deployment >
Applications >
Summary

Trend identification with confidence

impact of process, feedstock, solid erosion, inhibitor changes can be identified

Thickness (mm)

Thickness (mm)

Thickness (mm)

Thickness (mm)

No visible trend on UT measured thicknesses in the period - no corrosion / erosion activity

Visible downward trend in UT measured thickness over time
Trend constant over the period – metal loss at constant rate

No trend on the UT measured data from August-November
From December sustained metal loss

October, December: no metal loss
September, November, January: metal loss - due to crude blend variations

www.permasense.com Experts in Remote Monitoring Solutions

Industry challenges
Company
Solutions >
System outputs
Data
Reporting
Localised corrosion
System benefits
Business case
Technology
Deployment >
Applications >
Summary

Huge enhancement in data *quality* and *frequency* over manual UT inspection

- Permasense: Measurements every 12 hours within +/- 1-2 mils variation (+/- 25-50 microns); catch onset of corrosion events within days
- Manual UT Inspection: Years between measurements with +/- 20-50 mils variation (+/- 0.5-1.0 mm); corrosion rate calculation not possible, corrosion events missed



- Industry challenges
- Company
- Solutions >
- System outputs
- Data
- Reporting
- Localised corrosion
- System benefits
- Business case
- Technology
- Deployment >
- Applications >
- Summary

Thickness as a Function of Time

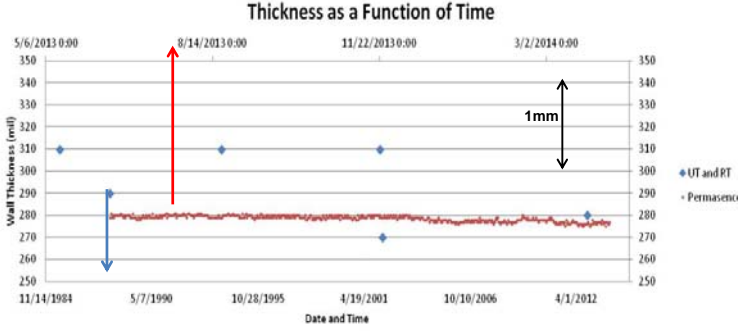

www.permasense.com
Experts in Remote Monitoring Solutions

Permasense Shape Indicator (PSI®) can detect onset of corrosion activity before wall loss even occurs

- Permasense measurements (AXC®) are not affected by internal surface morphology changes, making data easier to interpret
- PSI® detects changes in internal surface morphology
 - early detection of corrosion activity
 - Further insight into type of corrosion mechanism occurring



- Industry challenges
- Company
- Solutions >
- System outputs
- Data
- Reporting
- Localised corrosion
- System benefits
- Business case
- Technology
- Deployment >
- Applications >
- Summary

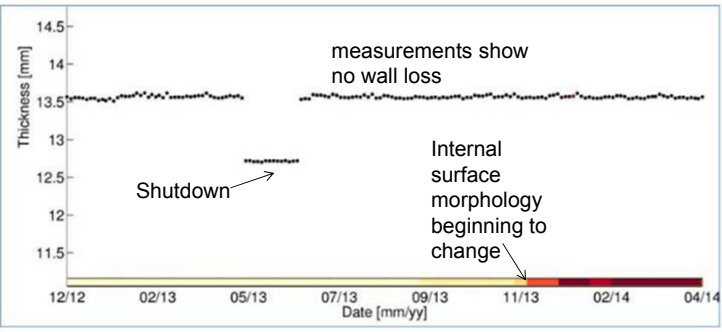

www.permasense.com
Experts in Remote Monitoring Solutions



Continuous high-quality data enables...

- **Confidence in asset management**
 - early identification of corrosion / erosion activity
 - understanding of causes – correlation with process condition changes
 - better forecasting of attainment of retirement thickness
- **Optimisation of prevention / mitigation strategies**
 - correlation of trends with inhibition strategy
- **Insight into impact of feedstock decisions**
 - rapid feedback with changes in crude slate
- **Cost-effective, safe measurement**
 - no cost of repeat measurements
 - no shutdown for measurement
 - no personnel exposure to high-risk locations









- Industry challenges
- Company
- Solutions >
- System outputs >
- System benefits
- Business case
- Technology
- Deployment >
- Applications >
- Summary

www.permasense.com
Experts in Remote Monitoring Solutions





Experts in remote monitoring solutions

Technology

www.permasense.com
Experts in Remote Monitoring Solutions

WT sensor waveguides enable mounting on hot pipework

SENSOR HEAD AT AMBIENT TEMPERATURE

PIPE OPERATES UP TO 600 °C / 1100 °F

www.permasense.com Experts in Remote Monitoring Solutions

permasense

- Industry challenges
- Company
- Solutions >
- System outputs >
- System benefits
- Business case
- Technology
- Deployment >
- Applications >
- Summary

Sensors use proven ultrasonic principles

Waveguide

Pipe wall

Surface signal

1st backwall reflection

2nd backwall reflection

Typical signal and wave path from the Permasense WT100 sensor

www.permasense.com Experts in Remote Monitoring Solutions

permasense

- Industry challenges
- Company
- Solutions >
- System outputs >
- System benefits
- Business case
- Technology
- Deployment >
- Applications >
- Summary



Refining applications

www.permasense.com Experts in Remote Monitoring Solutions



Proven applications: refining

NHT	ISOM	AMINE	SRU	TGT	FLARE SYSTEM
	REF	AROM EXT	BOILER FEED WATER	SWS	COOLIN G WATER
CDU	HCR	DHT	Typical locations <ul style="list-style-type: none"> • CDU Overheads • CDU/VDU naphthenic acid corrosion • FCC erosion, fractionator overheads • Sour water stripper • Amine system • Alky feed driers / main frac / deprop • Hydrotreater REAC, stripper overheads • Isomerisation, Reformer stabilisers 		
VDU	FCC	HF ALKY			
	VBU	DCU			

Industry challenges

Company

Solutions >

System outputs >

System benefits

Business case

Technology

Deployment >

Applications

Refining

Upstream

Power generation

Geothermal

Summary

Sensors installed on All metals found in Oil & Gas: from carbon and chrome steels & chrome steels to super-alloys

www.permasense.com Experts in Remote Monitoring Solutions



Refinery applications

Crude and Vacuum Unit Naphthenic Acid corrosion

www.permasense.com Experts in Remote Monitoring Solutions

Applications: Crude and Vacuum Distillation Tower Naphthenic Acid corrosion key issues and vulnerable areas

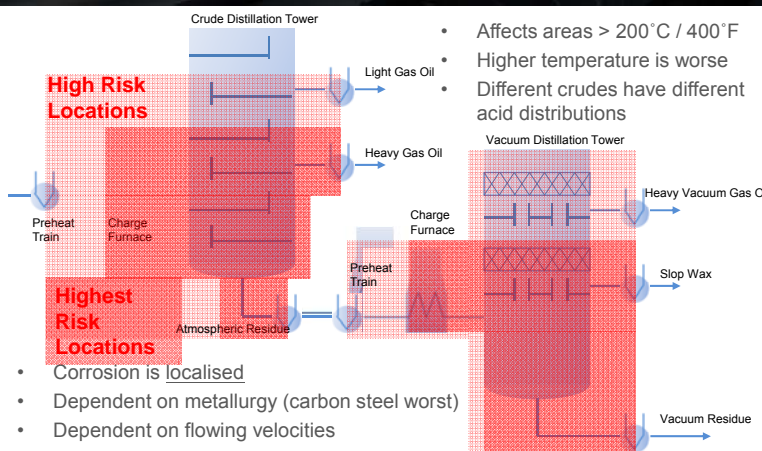

- Affects areas > 200°C / 400°F
- Higher temperature is worse
- Different crudes have different acid distributions

High Risk Locations

Highest Risk Locations

- Corrosion is localised
- Dependent on metallurgy (carbon steel worst)
- Dependent on flowing velocities
- Presence of an iron sulphide passivation layer can provide some protection
- Inhibition chemicals are well proven
- Difficult to make reliable manual UT measurements

permasense

Industry challenges

Company

Solutions >

System outputs >

System benefits

Business case

Technology

Deployment >

Applications

Refining

Upstream

Power generation

Geothermal

Summary

www.permasense.com Experts in Remote Monitoring Solutions

Applications: Crude and Vacuum Distillation Tower Naphthenic Acid corrosion key parameters driving naphthenic acid corrosion rates

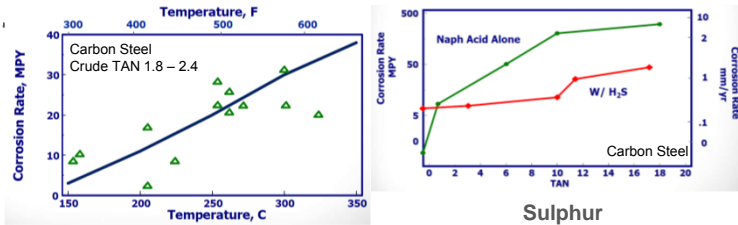

Material	TAN	Linear Velocity ft/sec (m/sec)	Corrosion Rates at elbows mm/yr (MPY)	mm/yr (MPY)					
				Temp	Acid No.	C.S.	410	304	316
C.S.	1.5	73 (22.5)	12 (472)	377°C (711°F)	3+	48+ (1890+)	22 (870)	0.09 (3.5)	0.06 (2.3)
C.S.	1.5	26 (8)	6 (236)	342°C (648°F)	3.6	49+ (1930+)	0.5 (20)	33 (1300)	0.08 (3.1)
5Cr-1/2Mo	1.5	73 (22.5)	2 (79)	338°C (640°F)	3.6	48+ (1890+)	30 (1180)	30 (1180)	4.8 (190)
5Cr-1/2Mo	1.5	26 (8)	0.6 (24)	300°C (572°F)	4.1	37 (1460)	5.8 (230)	10 (390)	0.01 (0.4)
9Cr-1Mo	1.5	73 (22.5)	0.7 (28)						

permasense

- Industry challenges
- Company
- Solutions >
- System outputs >
- System benefits
- Business case
- Technology
- Deployment >
- Applications
 - Refining
 - Upstream
 - Power generation
 - Geothermal
- Summary

Applications: Crude and Vacuum Distillation Tower Naphthenic Acid Corrosion outline Permasense corrosion monitoring solution

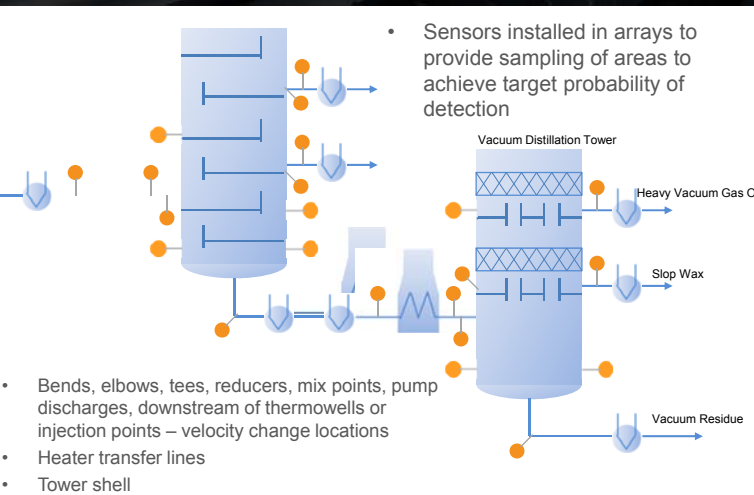

permasense

- Industry challenges
- Company
- Solutions >
- System outputs >
- System benefits
- Business case
- Technology
- Deployment >
- Applications
 - Refining
 - Upstream
 - Power generation
 - Geothermal
- Summary

Typically 10-20 measurement locations, 10-30 sensors per location

Applications: Crude and Vacuum Distillation Tower Naphthenic Acid corrosion outline Permasense corrosion monitoring solution

Transfer Line – 26 sensor array 6”/8” Bend – 14 sensor array

- Monitors effectiveness of inhibitor in 'at risk' locations
- Gives confidence to gradually increase acidity of crude slate

www.permasense.com Experts in Remote Monitoring Solutions

Industry challenges
Company
Solutions >
System outputs >
System benefits
Business case
Technology
Deployment >
Applications
Refining
Upstream
Power generation
Geothermal
Summary

Case study: Naphthenic Acid corrosion monitoring

0.3 mg KOH/g TAN 0.35 mg KOH/g TAN

0.2 mm/y (7 mpy) 0.5 mm/y (22 mpy)

Transition/Roughness

Wall thickness trend

Corrosion rate

PSI® Scale

- Customer began processing higher TAN crude in early December
- Very rapid sensor response to roughening back-wall shape from the onset of corrosion – shown on PSI® colour-bar scale
- Higher corrosion rate trend established within 2 weeks

www.permasense.com Experts in Remote Monitoring Solutions

Industry challenges
Company
Solutions >
System outputs >
System benefits
Business case
Technology
Deployment >
Applications
Refining
Upstream
Power generation
Geothermal
Summary

Case Study: Feedstock variation: Correlation of PSI readings with variation in crude sulphur levels



- Industry challenges
- Company
- Solutions >
- System outputs >
- System benefits
- Business case
- Technology
- Deployment >
- Applications
- Refining
- Upstream
- Power generation
- Geothermal
- Summary

- German refiner with 230 sensors installed, 80 installed on CDU
- 17 sensors on kerosene draw showed internal surface roughness changes – corrosion occurring - (detected by PSI) correlating to small variations in crude sulphur levels.



PSI scale

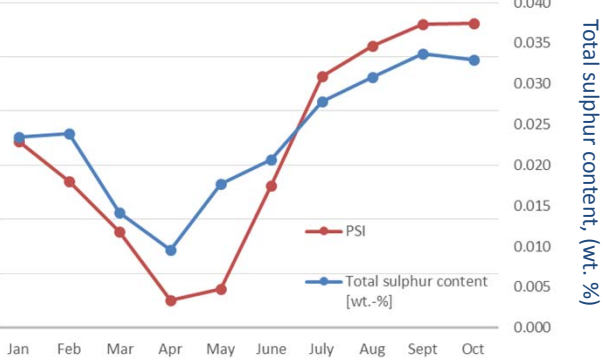

Month	PSI (Scale)	Total sulphur content (wt. %)
Jan	0.025	0.020
Feb	0.018	0.020
Mar	0.012	0.015
Apr	0.005	0.010
May	0.008	0.018
June	0.020	0.022
July	0.035	0.028
Aug	0.038	0.032
Sept	0.038	0.035
Oct	0.038	0.035

www.permasense.com Experts in Remote Monitoring Solutions



Experts in remote monitoring solutions

Other Crude Unit Case Studies

www.permasense.com Experts in Remote Monitoring Solutions

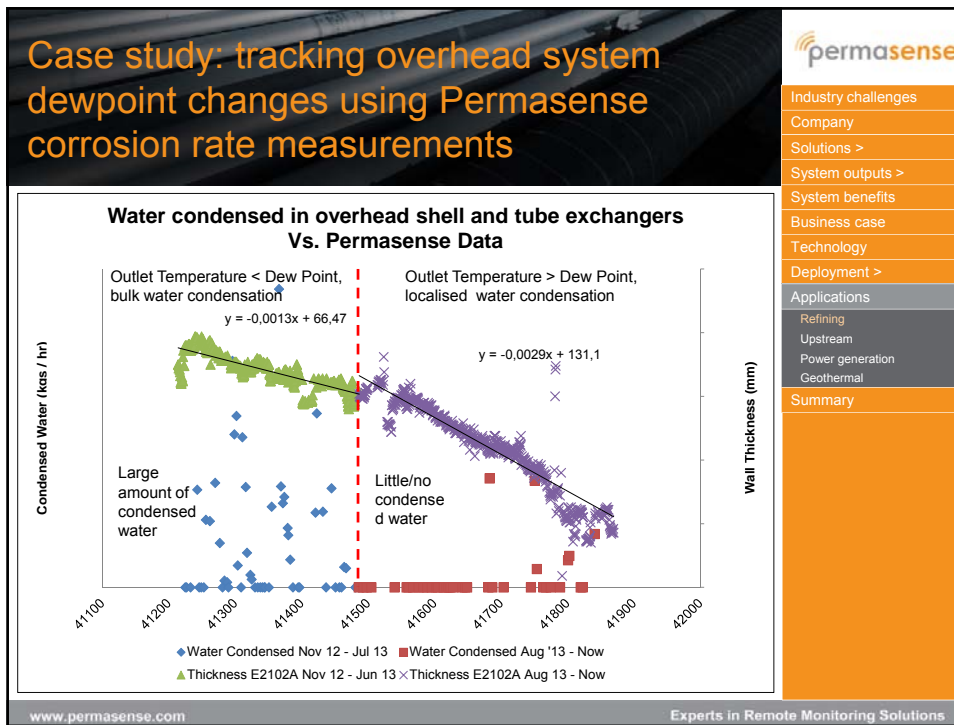

permasense

- Industry challenges
- Company
- Solutions >
- System outputs >
- System benefits
- Business case
- Technology
- Deployment >
- Applications
- Refining
- Upstream
- Power generation
- Geothermal
- Summary

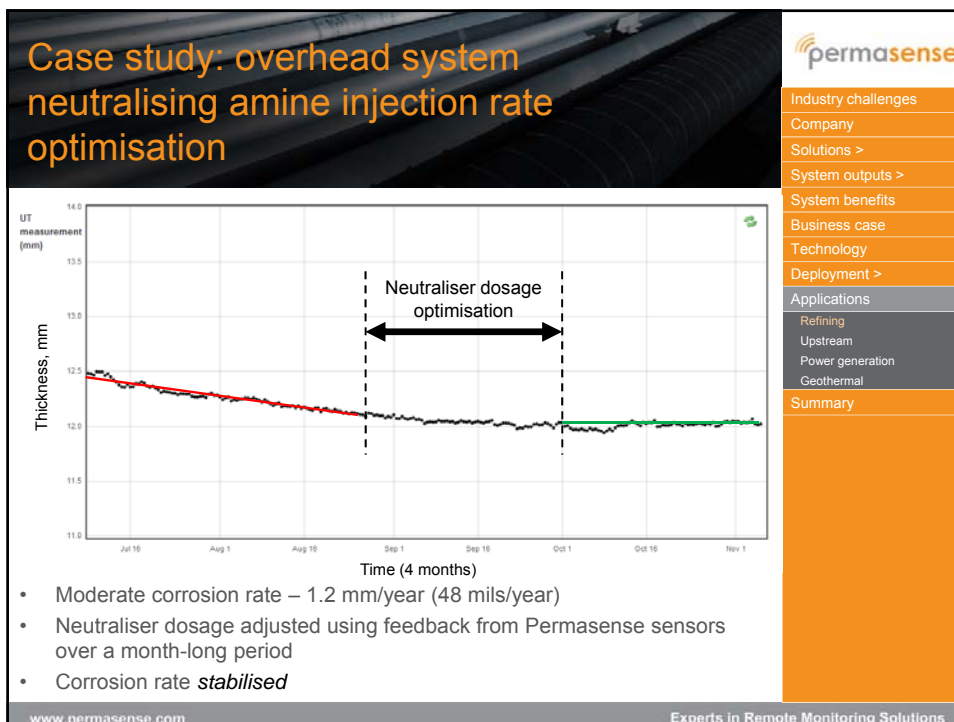

permasense

- Industry challenges
- Company
- Solutions >
- System outputs >
- System benefits
- Business case
- Technology
- Deployment >
- Applications
- Refining
- Upstream
- Power generation
- Geothermal
- Summary

Case study: monitoring overhead corrosion impact of (intermittent) organic chlorides in crude

Thickness, mm

Time (6 months)

- Continuous wall thickness monitoring enabled correlation of corrosion rate with crude slate
- Sensors in CDU overheads showed higher corrosion rate than expected for a particular batch of crude; no correlation with overhead inorganic chlorides
- Prompted refinery to investigate presence of organic chlorides from that crude batch, which was confirmed by detailed lab analysis

www.permasense.com Experts in Remote Monitoring Solutions

- Industry challenges
- Company
- Solutions >
- System outputs >
- System benefits
- Business case
- Technology
- Deployment >
- Applications
- Refining
- Upstream
- Power generation
- Geothermal
- Summary

Case study: inspector safety / run length management in crude furnace

Gelsenkirchen refinery operated by BP

- Corrosion monitoring on cast carbon steel u-bends
 - ~ wall thickness ~ 25mm (1")
 - ~ operating at 380°C (720°F)
- High temperature
 - ~ prevented accurate manual ultrasonic wall thickness measurement
 - ~ would have exposed inspectors to significant **hazard**
- Permasense system installed to ensure continued safe operation until shutdown

Measured wall thickness (mm)

Timeline

The system:

- Secured operation with **confidence** until turnaround
- Has been delivering reliable measurement data for > 4 years now

www.permasense.com Experts in Remote Monitoring Solutions

- Industry challenges
- Company
- Solutions >
- System outputs >
- System benefits
- Business case
- Technology
- Deployment >
- Applications
- Refining
- Upstream
- Power generation
- Geothermal
- Summary

Case study: improved insight into impact of feedstock decisions

Time (4 months)	Wall thickness (mm)	Corrosion Rate
Apr 1 - May 15	~7.2	Stable corrosion rate
May 15 - Jul 1	~6.9	Accelerated corrosion rate observed (0.3 mm in 16 days or 6.8 mmpy)
Jul 1 - Jul 16	~6.9	Stable corrosion rate

- One-month trial of new crude – 20-25% of total slate
- Sensors on kerosene draw-off from crude tower: increased corrosion rate
- Insight informed operational guidelines & inhibitor strategy for this crude slate

www.permasense.com Experts in Remote Monitoring Solutions

- Industry challenges
- Company
- Solutions >
- System outputs >
- System benefits
- Business case
- Technology
- Deployment >
- Applications
- Refining
- Upstream
- Power generation
- Geothermal
- Summary

Case study: Corrosion monitoring through extended run length

- Permasense sensors already installed in 20 known damage locations
- Have successfully extended runs between turnarounds from 3 to 5 years
- Intrusive electrical resistance probe tips need replacement after 3.5 – 4 years, but cannot be retracted for safety reasons
- Refinery is 'blind' for the most critical last year of the cycle
- Enhancing monitoring by adding Permasense sensors at the 120 ER probe locations across the refinery

www.permasense.com Experts in Remote Monitoring Solutions

- Industry challenges
- Company
- Solutions >
- System outputs >
- System benefits
- Business case
- Technology
- Deployment >
- Applications
- Refining
- Upstream
- Power generation
- Geothermal
- Summary



Refinery applications

Hydrocracker – feed system, reactor effluent air cooler and main Fractionator

www.permasense.com Experts in Remote Monitoring Solutions

Applications: Hydrocracker – feed, REAC and Fractionator bottoms

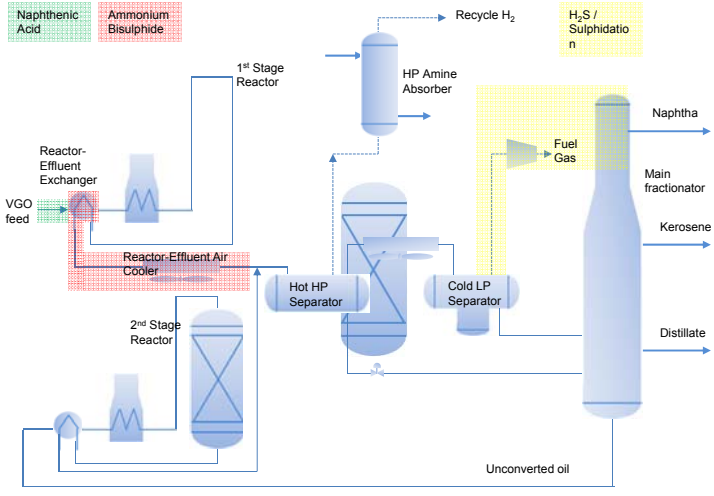

www.permasense.com

Experts in Remote Monitoring Solutions

Industry challenges

Company

Solutions >

System outputs >

System benefits

Business case

Technology

Deployment >

Applications

Refining

Upstream

Power generation

Geothermal



Summary

Typically 10-15 measurement locations, 10-15 sensors per location

Applications: Hydrocracker reactor effluent air cooler inlet



Industry challenges
Company
Solutions >
System outputs >
System benefits
Business case
Technology
Deployment >
Applications
Refining
Upstream
Power generation
Geothermal
Summary







- Known damage location
- 1" thick carbon steel
- 20-30 mpy corrosion rate measured manually
- Extensive inspection effort (and cost) for manual measurements on frequent basis
- 69 Permasense sensors installed in this location to enable close monitoring of corrosion and commissioning of inhibitor

www.permasense.com Experts in Remote Monitoring Solutions

Applications: Hydrocracker reactor effluent air cooler inlet



Industry challenges
Company
Solutions >
System outputs >
System benefits
Business case
Technology
Deployment >
Applications
Refining
Upstream
Power generation
Geothermal
Summary

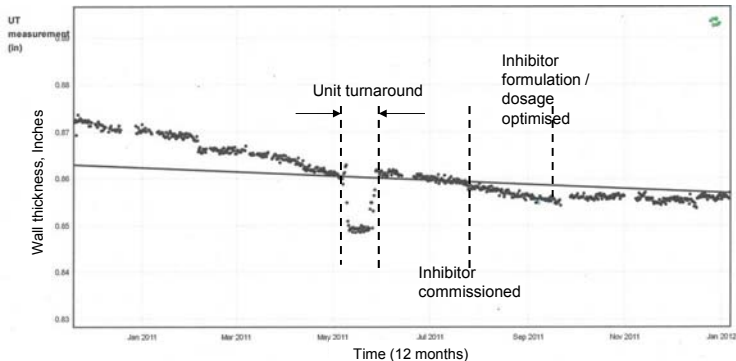

- Corrosion rate was ~15 -20 mpy at this location
- Inhibitor (at first) had no effect
- Inhibitor formulation and dosage were optimised based on the feedback from the sensors
- Corrosion rate was *stabilised*

www.permasense.com Experts in Remote Monitoring Solutions



Refinery applications

Amine System

www.permasense.com Experts in Remote Monitoring Solutions

Applications: Amine absorption and regeneration outline Permasense corrosion monitoring solution

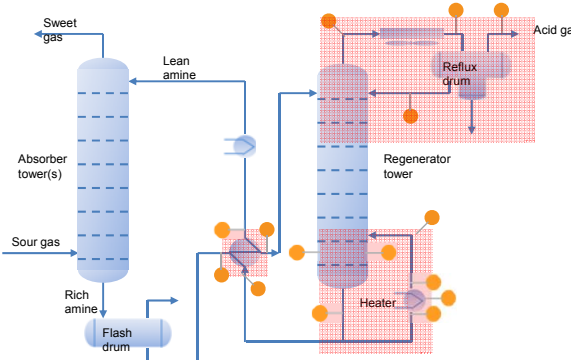

- Corrosion issues
 - High gas loading
 - Heat stable salts
 - Amine degradation
 - Oxygen contamination
- Corrosion is uniform and not so localised
 - Fewer measurements needed to represent entire system
 - Elbows, bends, tees, exchanger shells

Typically 10-15 measurement locations, 2-3 sensors per location

www.permasense.com

Experts in Remote Monitoring Solutions

permasense

- Industry challenges
- Company
- Solutions >
- System outputs >
- System benefits
- Business case
- Technology
- Deployment >
- Applications
- Refining
- Upstream
- Power generation
- Geothermal
- Summary



Experts in remote monitoring solutions

Refinery applications

Sour Water Stripping System

www.permasense.com Experts in Remote Monitoring Solutions

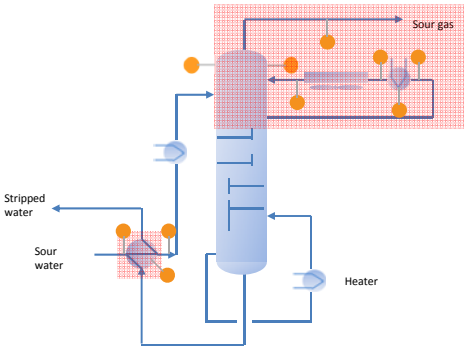

Applications: Sour Water Stripper

Industry challenges
Company
Solutions >
System outputs >
System benefits
Business case
Technology
Deployment >
Applications
Refining
Upstream
Power generation
Geothermal
Summary

Typically 5-10 measurement locations, 2-3 sensors per location

- Uniform corrosion mechanism (sulphidation)
- Fewer measurements needed to represent entire system
- Overhead reflux exchanger is particularly prone to attack, unless higher grade material is used

www.permasense.com Experts in Remote Monitoring Solutions

Case study: Sour Water Stripper overhead corrosion



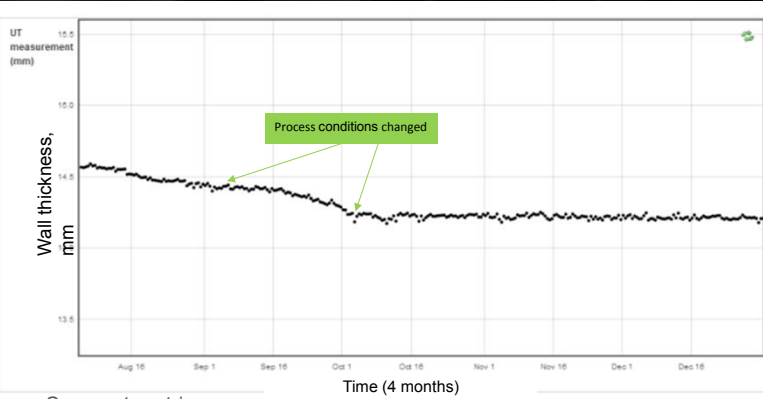

- Sour water stripper overheats exchanger
 - Carbon steel, high corrosion rate at 1.5 mm/year (60 mpy)
- Process conditions adjusted and corrosion dramatically *reduced*

Industry challenges

Company

Solutions >

System outputs >

System benefits

Business case

Technology

Deployment >

Applications

Refining

Upstream

Power generation

Geothermal

Summary

www.permasense.com Experts in Remote Monitoring Solutions

Case study: feedstock variation



- European refinery operated in Summer/Winter bitumen campaign modes
- Changes in crude slate from high sulphur (summer) to low sulphur (winter) results in marked variation in corrosion rate, as demonstrated by Permasense sensor data

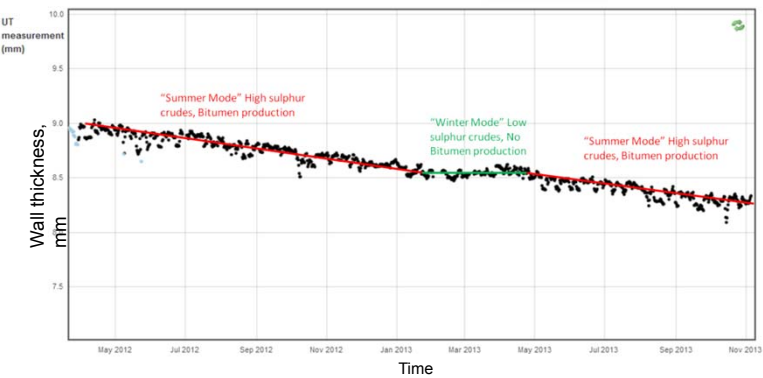

Industry challenges

Company

Solutions >

System outputs >

System benefits

Business case

Technology

Deployment >

Applications

Refining

Upstream

Power generation

Geothermal

Summary

www.permasense.com Experts in Remote Monitoring Solutions

Case study: chemical treatment optimisation



FGR middle compressor service liquid supply

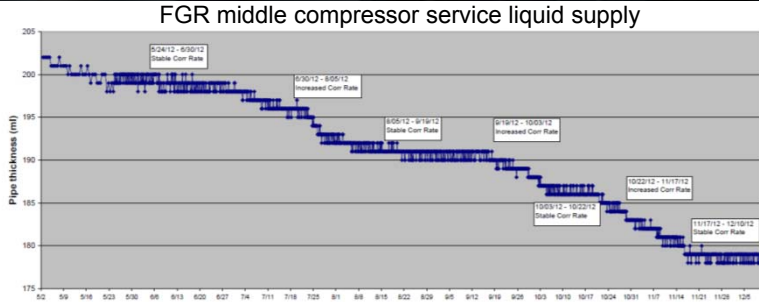

- Flare gas recovery system
- Underlying corrosion rate varying with process flow and level of contaminants, especially merox air routing
- Sensor data demonstrates *effectiveness* of oxygen scavenger injection
- Chemical supplier proactively used sensor data to adjust injection rate and stabilise corrosion rate
- Sensors responded rapidly to changing corrosion rate
- Customer calculated benefit of **\$2.3 Million/year**

Industry challenges

Company

Solutions >

System outputs >

System benefits

Business case

Technology

Deployment >

Applications

Refining

Upstream

Power generation

Geothermal

Summary

www.permasense.com

Experts in Remote Monitoring Solutions

Case study: material selection



Uniform thinning : sulphidation



Localised corrosion: Naphthenic Acid



- Question for refinery: which corrosion mechanism is dominant?
- Needed to be understood to decide change of pipe material from carbon steel to:
 - 5Cr-1/2Mo, if uniform corrosion
 - 1.4571, if naphthenic acid corrosion

" the data from the Permasense sensors over a year clearly showed localised thinning / pitting in the pipes as well as in the column..."

"This thinning is interpreted as naphthenic acid corrosion and resulted in the recommendation to upgrade to 1.4571"

Industry challenges

Company

Solutions >

System outputs >

System benefits

Business case

Technology

Deployment >

Applications

Refining

Upstream

Power generation

Geothermal

Summary

www.permasense.com

Experts in Remote Monitoring Solutions

Application of Permasense in HF Alkylation units: Overview of corrosion issues



Industry challenges
Company
Solutions >
System outputs >
System benefits
Business case
Technology
Deployment >
Applications
Refining
Upstream
Power generation
Geothermal
Summary

- Most equipment is constructed from carbon steel. Upon contact with highly concentrated acid, a stable iron fluoride layer is formed inside the equipment
- Upon contact with an acid/water mix an unstable and non protective hydrate scale is formed which sweats

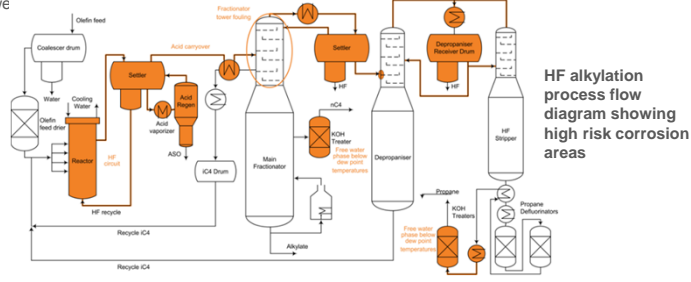

HF alkylation process flow diagram showing high risk corrosion areas

- Corrosion is often aggressive, short-term and transient, driven by process upsets, like excursions of temperature or water content, or changes in feedstock quality
- corrosion is difficult to track using traditional methods such as manual ultrasound that are carried out periodically.

www.permasense.com
47
Experts in Remote Monitoring Solutions

Commercial impact of HF alkylation unit shutdowns are high. Permasense systems are well suited to application



Industry challenges
Company
Solutions >
System outputs >
System benefits
Business case
Technology
Deployment >
Applications
Refining
Upstream
Power generation
Geothermal
Summary

- Impact**
- Delays to gasoline shipments
- Distressed sales of butane or iso-butane
- Leak of light hydrocarbons or of hydrofluoric acid to atmosphere
 - Potential health and safety impact
 - Potential for explosion
 - Damage to corporate brand image
- Permasense monitoring systems**
 - reliably determine if corrosion is taking place in the high risk areas, helping to enable rigorous management of the unit integrity
 - highlight the correlation between corrosion rates and changes in feedstock and process conditions, particularly due to short term upsets
 - minimise the risk of leaks and enables better forecasting of equipment retirement
 - facilitate optimisation of corrosion prevention and mitigation strategies
 - enable justification of metallurgy upgrade decisions

www.permasense.com
48
Experts in Remote Monitoring Solutions

Permasense solution for high-risk locations for HF alkylation units

Outline monitoring locations for HF alkylation unit

- Approximately 30 monitoring locations, with 2- 4 sensors per location
- At lower temperature
 - Compact sensors can be installed, using studs, clamps or magnetic mounting

permasense

Industry challenges

Company

Solutions >

System outputs >

System benefits

Business case

Technology

Deployment >

Applications

Refining

Upstream

Power generation

Geothermal

Summary

www.permasense.com
49
Experts in Remote Monitoring Solutions

Case Study: US Refiner avoided unscheduled shutdown of HF Alky unit, saving estimated \$10M

- Expected corrosion issue in Monel acid re-run tower, first detected through manual inspection
- The tower base was inside a concrete skirt, with a temperature inside the enclosure of 200°F and 5' clearance height. Inspectors were making manual measurements very regularly inside this confined and difficult space in full chemical suits, with a significant inventory of HF acid overhead.
- Customer was planning to shutdown the unit to make a complete inspection of the tower.
- However, Permasense manufactured two custom-built saddles to fit the geometry of the tower base, which were fixed to the tower using epoxy adhesive. Permasense sensors were fitted and the sensor data showed that, although there was some corrosion activity at the location, it was much less than was indicated by the earlier manual measurements.
- On the basis of this data, the customer built confidence to keep the unit on-stream, avoiding a very costly 10 day unplanned shutdown (including decontamination etc).

permasense

Industry challenges

Company

Solutions >

System outputs >

System benefits

Business case

Technology

Deployment >

Applications

Refining

Upstream

Power generation

Geothermal

Summary

www.permasense.com
50
Experts in Remote Monitoring Solutions

Installation pictures: refinery pipework



www.permasense.com Experts in Remote Monitoring Solutions

permasense

- Industry challenges
- Company
- Solutions >
- System outputs >
- System benefits
- Business case
- Technology
- Deployment >
- Applications
 - Refining
 - Upstream
 - Power generation
 - Geothermal
- Summary

Refineries: quick and easy installation



www.permasense.com Experts in Remote Monitoring Solutions

permasense

- Industry challenges
- Company
- Solutions >
- System outputs >
- System benefits
- Business case
- Technology
- Deployment >
- Applications
 - Refining
 - Upstream
 - Power generation
 - Geothermal
- Summary

Refineries: array deployment for localised corrosion



www.permasense.com

Experts in Remote Monitoring Solutions

- permasense
- Industry challenges
- Company
- Solutions >
- System outputs >
- System benefits
- Business case
- Technology
- Deployment >
- Applications
 - Refining
 - Upstream
 - Power generation
 - Geothermal
- Summary

Refineries: installation on complex geometry no issue



www.permasense.com

Experts in Remote Monitoring Solutions

- permasense
- Industry challenges
- Company
- Solutions >
- System outputs >
- System benefits
- Business case
- Technology
- Deployment >
- Applications
 - Refining
 - Upstream
 - Power generation
 - Geothermal
- Summary

Refineries: air cooler inlet headers



www.permasense.com

Experts in Remote Monitoring Solutions

permasense

- Industry challenges
- Company
- Solutions >
- System outputs >
- System benefits
- Business case
- Technology
- Deployment >
- Applications
 - Refining
 - Upstream
 - Power generation
 - Geothermal
- Summary

Refineries: air cooler headers



www.permasense.com

Experts in Remote Monitoring Solutions

permasense

- Industry challenges
- Company
- Solutions >
- System outputs >
- System benefits
- Business case
- Technology
- Deployment >
- Applications
 - Refining
 - Upstream
 - Power generation
 - Geothermal
- Summary



Petrochemical Case Studies

www.permasense.com Experts in Remote Monitoring Solutions

Petrochemical Case Study: Data enabled fast detection of increased corrosion activity and online corrosion inhibition optimisation

- The Asian petrochemical client was concerned that elevated sulphur level could lead to corrosion of the carbon steel piping within their Condensate Feed Unit
- A Permasense sensor system was installed on the De-ethanizer unit, with a focus on the Overhead condenser as circled in red below

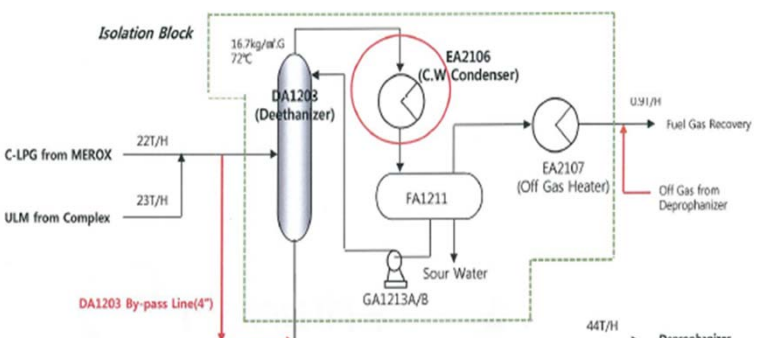

permasense

- Industry challenges
- Company
- Solutions >
- System outputs >
- System benefits
- Business case
- Technology
- Deployment >
- Applications
- Refining
- Upstream
- Power generation
- Geothermal
- Summary

www.permasense.com Experts in Remote Monitoring Solutions

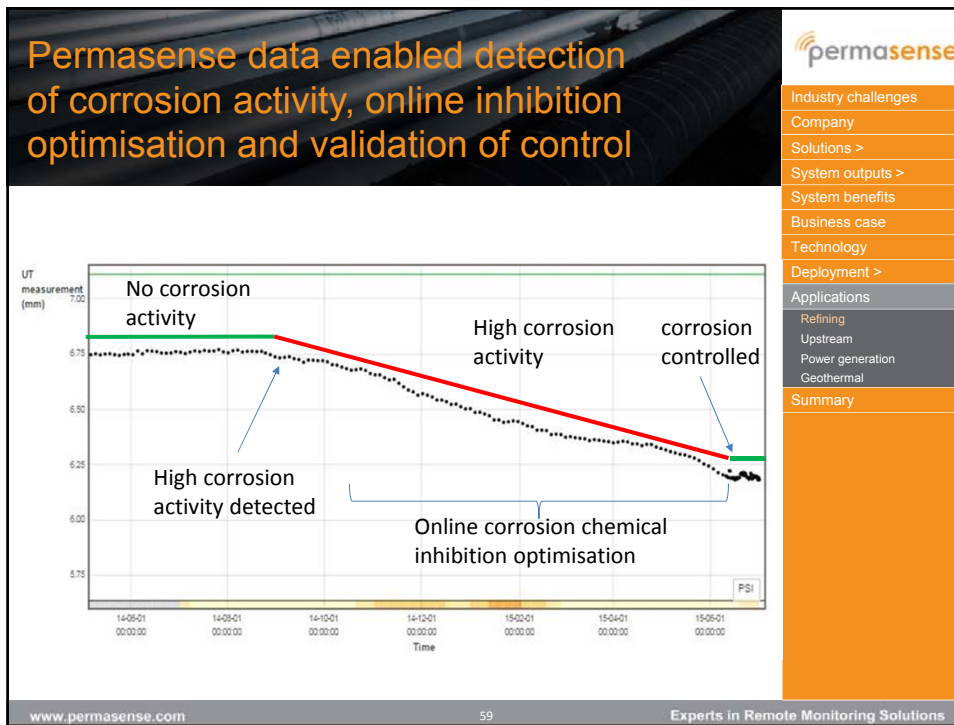

- Industry challenges
- Company
- Solutions >
- System outputs >
- System benefits
- Business case
- Technology
- Deployment >
- Applications
- Refining
- Upstream
- Power generation
- Geothermal
- Summary



- Industry challenges
- Company
- Solutions >
- System outputs >
- System benefits
- Business case
- Technology
- Deployment >
- Applications
- Refining
- Upstream
- Power generation
- Geothermal
- Summary

Drivers for deployment of continuous wall thickness measurement sensors

Operational Risk Management

Availability Improvement

Integrity Assurance

Personnel effectiveness

Personal

Process

Safety

Enhanced Decision Making

Production Maximisation

Feedstock diversification

Material selection

Equipment Life Management

Process optimisation

Shutdown planning

Treatment optimisation

Improved Profitability

Focus of this talk

permasense

Industry Challenges

Company

Technology

Solutions

System Outputs

System Benefits

Applications

Summary

www.permasense.com Experts in Remote Monitoring Solutions

Summary

- Operators using permanently installed continuous corrosion monitoring systems have a more *accurate* and *timely* understanding of the corrosion rates occurring within their facility
- Often installed as part of a safety or operational risk management programme
- Data is also providing valuable *insight* into the effect of changing operations on corrosion/erosion rates
- Data supports more effective risk-based decision making about
 - Feedstocks
 - Production Rates
 - Chemical inhibition strategy
 - Shutdown timing
 - Metallurgical upgrading
- System enables enhanced inspection strategies, where access is costly, dangerous or physically restricted
- Wireless data transmission facilitates *cost effective* and *rapid installation* in difficult working environments

permasense

Industry Challenges

Company

Technology

Solutions

System Outputs

System Benefits

Applications

Summary

www.permasense.com Experts in Remote Monitoring Solutions



Experts in remote monitoring solutions

Century House 100 Station Road Horsham RH13 5UZ, UK T +44 20 3002 3672	72 Carden Place Aberdeen AB10 1UL, UK T +44 1224 628 258	Permasense Americas Inc., 11490 Westheimer Rd Suite 850 Houston TX 77077 T +1 281 636 6436
--	---	--

www.permasense.com Experts in Remote Monitoring Solutions

Appendix 4

EFC WP13-WP15 Task force on corrosion in sour gas amine units treatment

(Johan van Roij)

Corrosion in Amine Gas Treating Units

On 8th Sept 2015, in a joint EFC WP13, WP15 “Task Force meeting” a proposal was launched to update the “Amine unit Corrosion in Refineries”, EFC publication 46 (Attached presentation). The motivation for updating the publication is that although it still is a very valuable and useful document, the publication is about 10 years old and there may be new experience especially when experience from similar units in Gas plants can be included and although the publication 46 described experience is very detailed there is also a need to translate the experience into something that can be used as a guideline to mitigate corrosion in amine Gastreating units.

The proposal to update the guideline included:

- Set up a joint task force WP13 - WP15 to include experience with corrosion in amine units in Gas plants.
- Perform a new industry survey in Refineries and Gas plants to obtain experience with amine corrosion. Besides obtaining experience about applied construction materials, operation conditions and observed corrosion, it is proposed to also obtain information about Corrosion Monitoring (techniques, locations, objectives, results) and Integrity Operating Windows (what parameters, what limits, what measurement locations, experience / effectiveness).
- Include a literature survey on amine corrosion and mitigation to turn the publication into a more complete overview.

Both within the WP13 and WP15 (WP13 meeting 8th Sep and WP15 meeting 9th Sep) there was agreement that working on an update of the EFC publication 46 and including amine units in Gas plants makes sense. A task force team was set up. Interested people from Gas plants and Refineries are still encouraged to join the team. Currently the following people volunteered to contribute:

WP13:

- Dr Peter Wilson (Corrosion Risk Management),
- Michel Bonis (Total),
-

WP15:

- Dr Slawomir Kus (Honeywell)
- Dr Mabruk Issa Sulelman (TAKREER),
- Jean Kittel (IFP Energies nouvelles-Lyon),
- Johan van Roij (Shell) volunteered to be the focal point of the task force.

The volunteers of the WP13 indicated that they foresee that they can only contribute in a limited way such as reviewing and not attending (too much) meetings.

All WP13 and WP15 members are still encouraged to come up with ideas on how to update the Publication

The following way forward is proposed:

- Next meeting of the task force: during the WP15 2016 spring meeting in April.
- In the meantime until April 2016: The task force members think about the proposal and come up with ideas etc:
 - What experience should be included (e.g. the above mentioned and what is still missing)?
 - Do we need input from process people (and, if so, what input)?
 - Who can and how to conduct an amine corrosion literature survey?
 - How to set up an industry survey on amine corrosion experience and format?
 - Way forward and time-line?
 - Do we need more volunteers and promotion of the idea and obtaining more volunteers (if needed)?
 - Do we need a meeting (teleconference) before April 2016 and/or communicate by e-mail?
 - Other ideas / Anything else?
- Johan van Roij volunteered to be the focal point for the task force and can be contacted with ideas, contributions, etc. (by the task force members and other interested people).



AMINE UNITS – UPDATE OF PUBLICATION 46? INTEGRITY OPERATING WINDOWS AND EXPERIENCE

EFC WP13+15,
Sep 2015



Johan van Roij (Shell Global Solutions International B.V.),

CONTENT - UPDATE OF PUBLICATION 46?

- Introduction
- Corrosion mechanisms and Integrity Operating windows in amine units
 - What are IOWs
 - Degradation mechanisms and IOWs in literature
- Update of publication 46?
 - If so: Content of update and how to continue?

European Federation of Corrosion Publications
NUMBER 46

2007

Amine unit corrosion in refineries

J. D. Harston and F. Ropital

QUOTE FROM THE INTRODUCTION PUBL. 46

The European Federation of Corrosion (EFC) Refinery Corrosion Working Party 15 has discussed a wide variety of topics since its first meeting in 1996. At one meeting a presentation was made on corrosion associated with amine units and this subject received much interest from the members. As a result of this it was decided that it would be beneficial to carry out a survey of corrosion on the amine units with which the members were associated.

This was seen as a good topic for investigation for a number of reasons:

- Many sites had experienced various corrosion and cracking problems associated with this type of plant and some of these had been shared with the group.
- Some sites were in the process of changing from one type of amine to another; so it was of interest to see whether any differences exist between corrosion-related problems with the different types of amine.
- Corrosion on amine units is fairly complex since it involves various corrosion, erosion and cracking mechanisms and is affected significantly by process parameters and the materials of construction.
- The subject was also thought to be non-proprietary and therefore participants did not have reservations about sharing their data. Anonymity of the data supplied was, however, preserved by participants sending in their data to the group via the EFC Scientific Secretary.

The amine unit corrosion survey covered the following amine types:

- Methyldiethanolamine (MDEA).
- Diethanolamine (DEA).
- Monoethanolamine (MEA).
- Diisopropanolamine (DIPA).

The findings of the survey emphasise the importance of careful process control and the beneficial effect of upgrading to austenitic stainless steel in a number of areas.

TO ADRESS AFTER THIS PRESENTATION:

- Is there a need for an update or addition of #46?
 - And what kind of update?
 - Just more experience and added in the same format (operation conditions, experience, etc.)?
 - Can the experience be used to come up with practical guidelines (e.g. As proposed in this presentation: Integrity Operating Windows)?
 - Anything else?
-
- How to continue?

COOPERATION WITH WP13?

- Gas treating units: removing acid gases (CO_2 and/or H_2S) from gas streams using amine solvents
 - Gas streams in refineries (Downstream)
 - Gas streams in Oil and Gas production (Upstream)
- Sharing experience can help to improve integrity management – improve safe operation

SHARING INFORMATION? WHAT INFORMATION?

- Experience of failures / corrosion rates in relation to operation conditions (and applied construction materials)
- But how to go from experience to practical guidelines?
 - Integrity Operating Windows (parameters and limits)?

INTEGRITY OPERATING WINDOW (IOW)

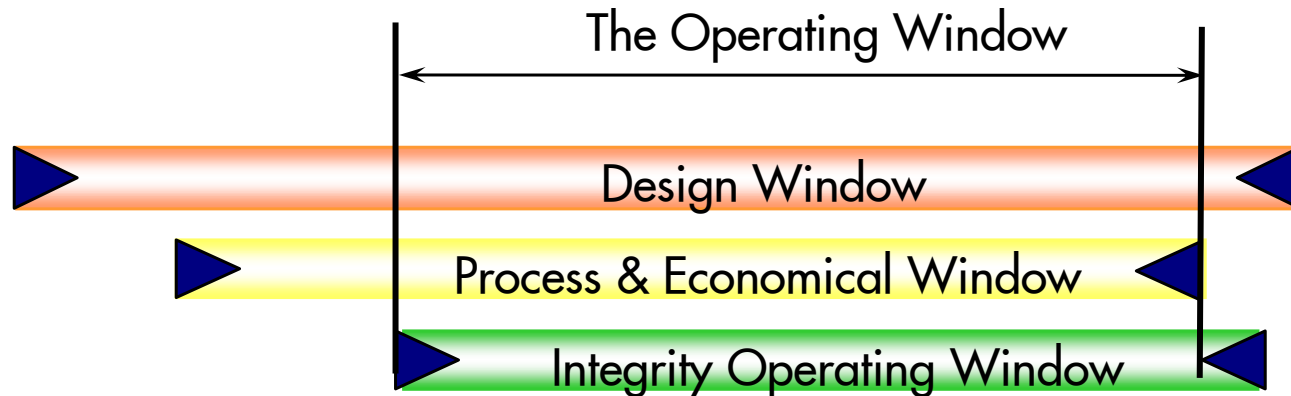

E.g. API RP 584 (2014): Integrity Operating Windows

For integrity management:

e.g. To ensure anticipated corrosion rates, life expectancies are met

- Operate within the IOW (temperature, flow rate, acid gas loading, lean solvent loading, pH, impurities, chloride content, etc.).
- Define actions in case of operating outside the IOW (who does what action)
 - Corrective actions or monitoring and inspection

OPERATING WINDOW - INTEGRITY

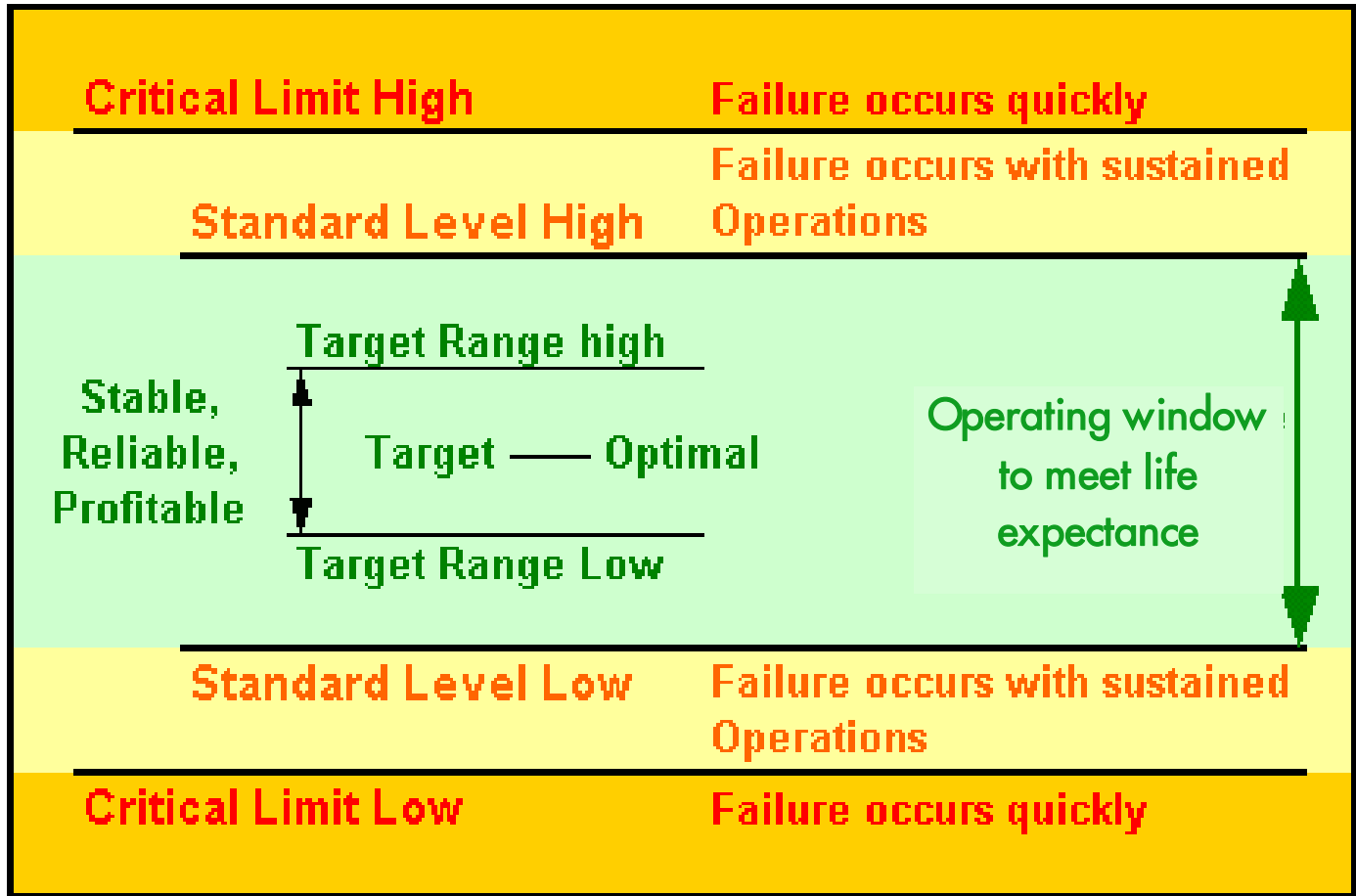
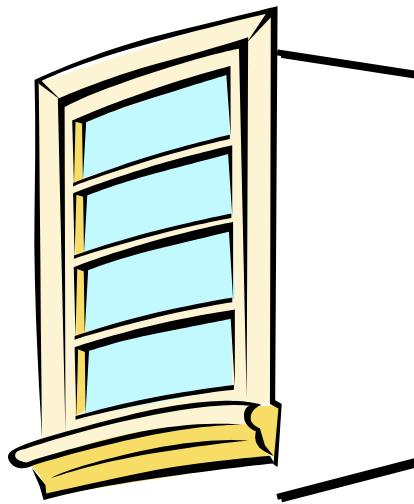

Target range = actual

Standard level = integrity

WHY USE IOW?

- Inspection plan / life expectance is defined assuming operations are steady and follow corrosion rate assumptions
- Life expectance and inspection plan are based on historic inspection data and/or known generic relation between operating conditions and the corrosion rates for the applied construction materials.
- However operation can change over time.
 - Solvents degrade
 - Change in operation
 - Gradual operation changes over time (aging plants)
 - Difference in feed composition

IOWs monitoring and control can help to maintain the corrosion rates within the acceptable range and assure life expectance.

EXPERIENCE ON IOW NEEDED

Although IOW limits need to be tailored to unit specific operation (using unit operation and inspection history) and can be solvent type specific it seems that most IOW (parameter and limits) are rather generic.

- Are IOWs already widely applied?
- What parameters and limits are used?
- Does it work well and what are the difficulties?

Results of industry survey may provide / answer:

- What parameters are applied and what are the limits?
- Are limits solvent type dependent?
- Guidelines on how to use IOWs for integrity management in amine gastreating units
- Etc.

IOW LIMITS IN LITERATURE

The in this presentation provided corrosion descriptions and IOW limits are indicative, “rule of thumb”, and obtained from literature.

For example, in NACE paper C2013-2207:

Johan van Roij (and others): “Materials Threats in Aging Amine Units” (contains reference list).

AMINE CORROSION (C-STEEL)



C-steel (for SS there are also limits but usually SS (e.g. 304, 316) is resistant under “normal” operation).

■ Solvent degradation:

- $< \sim 1-2\%$ heat stable salts (depending on solvent type)
- pH: decreasing indicates increasing corrosivity. Indication: pH should be higher than about 10.5 (can be solvent dependent)

■ Acid gas loading: *Max. acid gas loading depends on solvent type*

- Too much gas loading may cause flashing
- Too low acid gas loading limits protective scale formation: API 945 recommends at least 5% by volume of H_2S

AMINE CORROSION (C-STEEL)

- **Solvent type:** Primary amines like mono-ethanolamine (MEA) and diglycolamine (DGA) are more corrosive than secondary amines like di-ethanolamine (DEA) and DIPA and these secondary amines are more corrosive than tertiary amines such as MDEA
- **Maximum amine concentration:** (e.g. 20 wt% for MEA; 30 wt% for DEA and about 50% for other solvents)
- **Temperature:** Limits are solvent type and service, H_2S or CO_2 , dependent. Rough indications:
 - Rich solvent temperatures ~ 80 °C
 - Lean solvent temperatures ~ 130 °C

AMINE CORROSION (C-STEEL)

Erosion – corrosion

- Prevent too high flow rates and flashing: API 945: $< 1.8 \text{ m/s}$ for C-steel

EXPERIENCE WITH IOWS FOR AMINE CORROSION

- Parameters influence each other: exceedance of more than one limit can accelerate corrosion (not linear!).
- Importance of solvent quality limits often underestimated.
- Proper actions need to be defined and carried out when limit exceedance occurs.

CORROSION MECHANISMS (LOCALISED)

- **Amine SCC of C-steel**
 - API RP 945 / NACE SP 0472- 2015: mitigate by stress relieving heat treatment ($635 \pm 14^{\circ}\text{C}$ ($1175 \pm 25^{\circ}\text{F}$) metal temperature for a minimum of one hour (for each 25 mm (1.0 in), or fraction thereof, of metal thickness)
- **“Wet H₂S service” : Hydrogen Blistering (HB), Hydrogen Induced Cracking (HIC), Stress Oriented Hydrogen Induced Cracking (SOHIC) of C-steel and Sulfite Stress Cracking (SSC).**
 - NACE MR0103 (to mitigate SSC)
 - “Clean” steels to mitigate HIC/SOHIC/HB
 - Stress relief heat treatment

Mixed H₂S/CO₂ service

■ C-steel

- Stress relief / PWHT (to mitigate SSC and ASSC)
- NACE MR0103 (to mitigate SSC)
- “Clean” steels (to mitigate HIC/SOHIC/HB)

■ SS (e.g. 304L) usually needed when

- Rich solvent temperatures > ~80 °C
- Lean solvent temperatures > ~130 °C
- High flow-rate / turbulent locations
- Note: NACE MR0103 applicable (to mitigate SSC)

Provided limits are indicative, “rule of thumb” see paper C2013-0002207

OBSERVED CORROSION IN AMINE GASTREATING UNITS

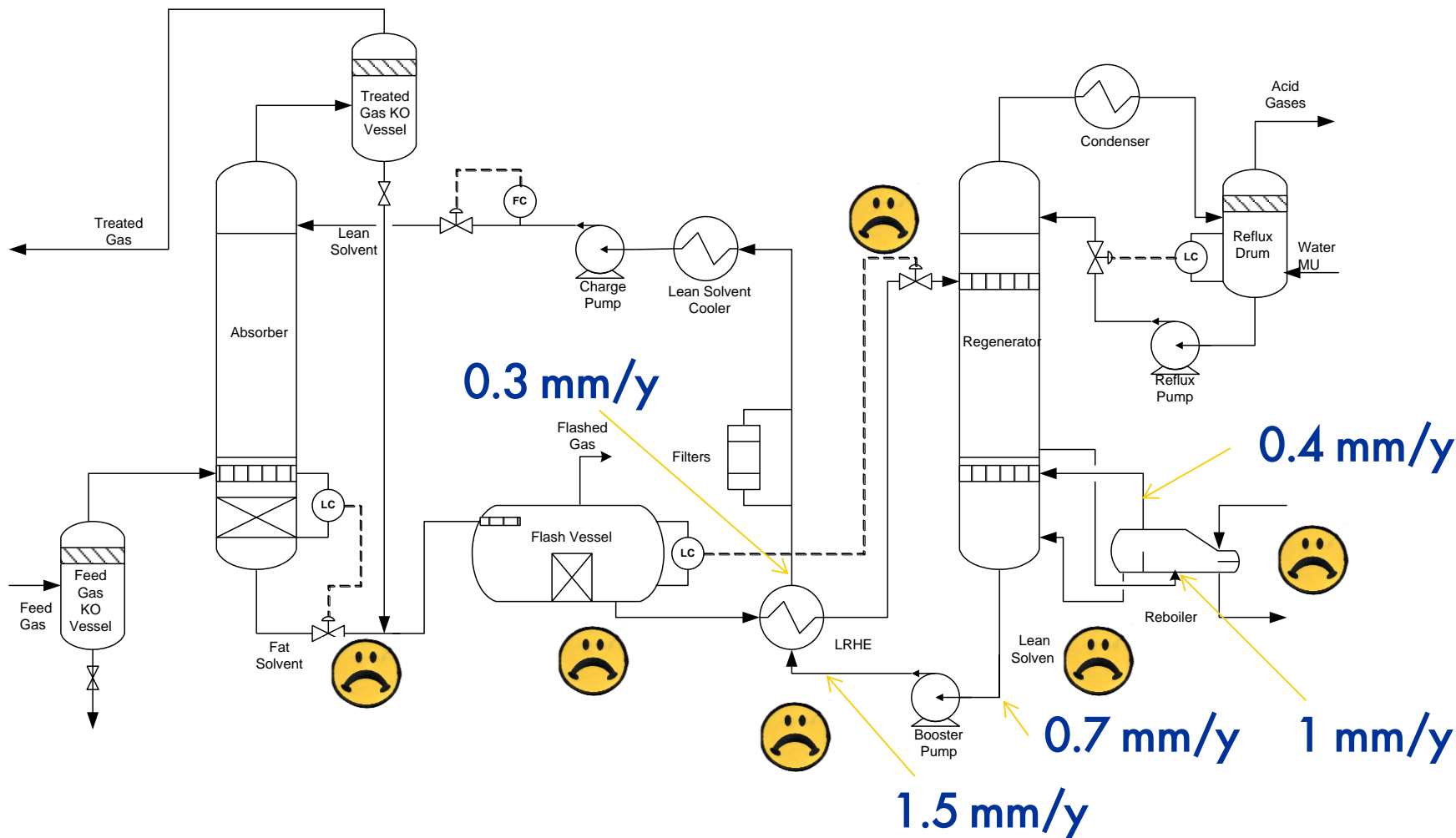

**Typical areas affected by increased solvent capacity use
(example: a total removal plant, worst findings for C-steel)**

UPDATE EFC PUBLICATION 46?

- Is there a need for an update or addition?
- And what kind of update?
 - Just more experience?
 - Can the experience be used to come up with practical guidelines (e.g. As proposed in this presentation: Integrity Operating Windows)?
- Anything else?

- How to continue?
 - Organise a team to sort that out? WP15 + WP13?